



**WATER SOLUTIONS**  
**NX FREQUENCY CONVERTERS**  
**APPLICATIONS MANUAL**



## INDEX

Document code: ud00861c

Date: 30.8.2005

<b>0.</b>	<b>General</b> .....	<b>4</b>
<b>0.1</b>	Commissioning notes .....	4
<b>0.2</b>	Drive status indication .....	4
<b>0.3</b>	Pressure/Level feedback .....	6
<b>0.4</b>	Function / terminal programming methods .....	7
<b>0.5</b>	Defining an input for a certain function on keypad.....	9
<b>0.6</b>	Circuit diagram of MultiMaster PFC and Advanced Level Control applications .....	10
<b>1.</b>	<b>Basic application</b> .....	<b>12</b>
<b>1.1</b>	Introduction.....	12
<b>1.2</b>	Motor protection functions in the Basic Application .....	12
<b>1.3</b>	Control I/O.....	13
<b>1.4</b>	Control signal logic in Basic Application .....	14
<b>1.5</b>	Basic Application – Parameter lists.....	15
<b>2.</b>	<b>MultiMaster PFC application</b> .....	<b>18</b>
<b>2.1</b>	Brief description of MultiMaster PFC application .....	18
<b>2.2</b>	Functionality .....	18
<b>2.3</b>	Chained control and autochange .....	19
<b>2.4</b>	Control I/O.....	20
<b>2.5</b>	Control signal logic in MultiMaster PFC Application .....	22
<b>2.6</b>	MultiMaster PFC Application – Parameter lists.....	23
<b>3.</b>	<b>Advanced Level Control application</b> .....	<b>37</b>
<b>3.1</b>	Brief description .....	37
<b>3.2</b>	Functionality .....	37
<b>3.3</b>	Level control and autochange .....	38
<b>3.4</b>	Control I/O.....	39
<b>3.5</b>	Control logic in Advanced Level Control Application .....	41
<b>3.6</b>	Advanced Level Control Application – Parameter lists.....	42
<b>4.</b>	<b>MultiFollower PFC application</b> .....	<b>56</b>
<b>4.1</b>	Brief description .....	56
<b>4.2</b>	Functionality .....	56
<b>4.3</b>	Chained regulation and autochange .....	57
<b>4.4</b>	Sharing of frequency reference .....	59
<b>4.5</b>	Control I/O for MultiFollower PFC .....	60
<b>4.6</b>	Control signal logic in MultiFollower PFC Application .....	62
<b>4.7</b>	MultiFollower PFC Application – Parameter lists.....	63
<b>4.8</b>	Keypad control (Control keypad: Menu M3).....	76
<b>4.9</b>	Expander boards (Control keypad: Menu M7) .....	76
<b>5.</b>	<b>Description of parameters</b> .....	<b>77</b>
<b>5.1</b>	Keypad control parameters.....	122
<b>6.</b>	<b>Appendices</b> .....	<b>123</b>
<b>6.1</b>	Parameters of motor thermal protection (ID's 704 to 708):.....	123
<b>6.2</b>	Parameters of Stall protection (ID's 709 to 712): .....	123
<b>6.3</b>	Parameters of Underload protection (ID's 713 to 716):.....	124
<b>6.4</b>	Fieldbus control parameters (ID's 850 to 859) .....	124

## 0. GENERAL

This manual describes the applications in package *ASFIG100V105.vcn*. The package includes the following applications:

- **Basic**, see page 11
- **MultiMaster PFC** (MMPFC), typically used in booster stations, see page 18
- **Advanced Level Control** (ALC), typically used for level control in storage tanks, see page 37
- **MultiFollower PFC** (MFPFC), typically used in booster stations, see page 56.

You can get your Vacon drive with *ASFIG100V105.vcn* preloaded from factory or you can download it to your Vacon drive afterwards.

Once you have the application package loaded into your drive select the application of your choice with parameter *S6.2* in system menu **M6**.

### 0.1 Commissioning notes

Always read chapter *Commissioning* in the product's User's Manual before you begin.

Set motor parameters according to the rating plate of the motor, and the parameters for the pump/fan/compressor.

#### 0.1.1 Using MultiMaster PFC or Advanced Level Control applications

It is important that the *Own ID* (ID1500) is set, and that all drives in the same chain have a unique number. Also the parameter *Number of Drives* (ID1502) has to be correct (MMPFC only)

In order to ensure the proper functioning of the communication, the diode and the other connections (See Figure 9) have to be made correctly. **The CMA and CMB have to be isolated from ground.** This is done by setting the jumpers of block X3 on the OPT-A1 board as shown in Figure 10.

If you want to test the Autochange function, set the *Interval Time* (ID1501) to **0**. Autochange will then occur after 5 min running. Remember to set a correct value after testing.

### 0.2 Drive status indication

On monitoring page V1.23 you can find the *Drive Status*. This value gives you information about the current status of the drive.

0 = OFF

**The automatics are not enabled via DIN1.**

1 = Communication line error

The communication between the drives has been down for more than 10 seconds. Check connections, diodes (also polarity), check that the CMA and CMB are open (See Figure 10 below). This error cannot be reset through the *Reset* command. To reset, turn DIN1 OFF and back ON in one or several drives.

This error may also appear if the grounding between the drives is insufficient. During tests of the system without complete cabling, connect the GND's (pin 13) of the drives with a wire.

2 = Stand-by

The drive is activated but waiting for permission to start (not used as leading drive) either via a start command from the other drives (MMPFC) or depending of the actual value (ALC).

**3 = Regulating**

The drive is working as the leading drive in the system.

**4 = Nominal production**

The drive has locked itself to nominal production frequency, ([ID102](#) or [ID1513](#)). The regulation is handled by another drive.

**NOTE:** In the *MultiFollower PFC* application this status has a different meaning:

**4 = Following**

The regulation is handled by another drive and this drive is following the frequency reference of the leading drive.

**5 = Sleeping**

The drive is the leading drive, but the actual value (pressure) is so high so the drive has gone into sleep status.

On monitoring page V1.24 you can also find a value called *Status Word*. In case of application malfunctioning, this value will be needed by Vacon service personnel.

### 0.3 Pressure/Level feedback

Individual sensor for each drive gives a redundant system (preferable).

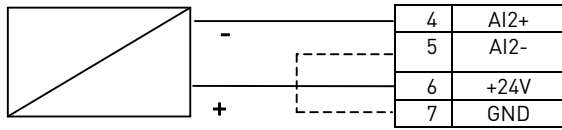

A common transducer can also be used.

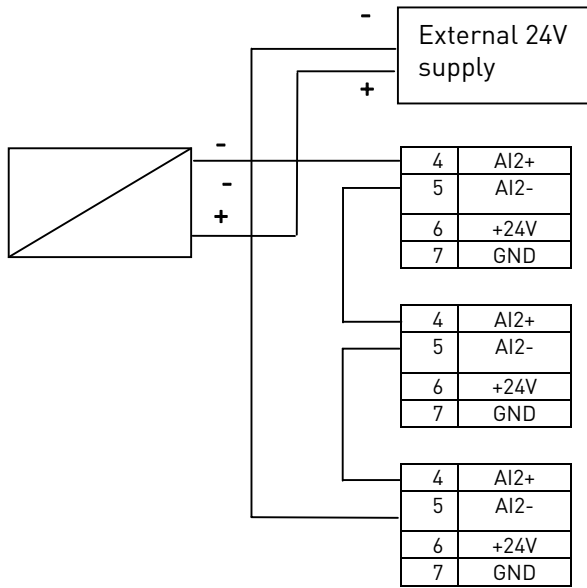

Or:

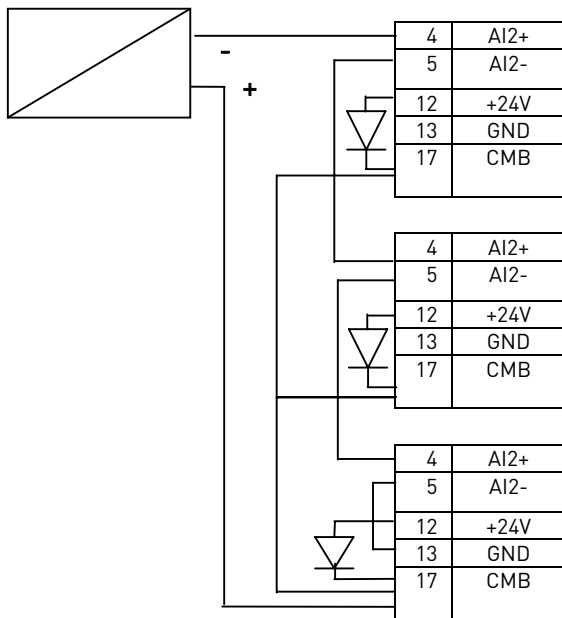

Figure 1. Different options to connect the pressure or level transmitter

## 0.4 Function / terminal programming methods

There are two methods for programming the input and output signals for the NX drives. The first method is called the **FTT** or **F**unction **T**o **T**erminal, the other method is called **TTF** or **T**erminal **T**o **F**unction.

In **FTT**, the terminal appears as a parameter and the user defines which function he wants to be activated with the specific terminal. This is the traditional way of I/O programming. See Figure 2.

In the figure, the function *Run Enable* is activated via DIN3.

### P2.2.2 DIN3 function:

0= Not Used  
1= Ext.Fault (cc)  
2= Ext.Fault (oc)  
**3= Run Enable**  
4= Acc/Dec....

Figure 2. FTT programming method

In **TTF**, the different functions appear as parameters and the user defines to which terminal he wants to connect the function.

This method allows a flexible use of additional I/O boards. See Figure 3.

P2.3.29.1 Ready = A.1  
P2.3.29.2 Run = 0.2  
P2.3.29.3 Fault = B.1  
P2.3.29.4 Fault, inv. = 0.1

Figure 3. TTF programming method

The examples in Figure 3 presuppose the connection of option boards OPT-A1 and OPT-A2:

'Ready' function is connected to slot A, 1st digital or relay output (D01),

'Run' function is connected to a virtual board with value TRUE, i.e. active

'Fault' function is connected to slot B, 1st digital or relay output (R01)

'Fault inverted' function is connected to a virtual board with value FALSE, i.e. NOT active

The first letter represents the slot (0 = virtual slot) and the number is the index number of the terminal.

Depending on the option board, there can be several (or no) inputs and/or outputs available.

If there are both inputs and outputs on the same board the first input is named A.1. **Note** that the first *output* is also named A.1.

### NOTE!

With this method, is it possible to have several signals connected to one hardware input, but only one signal can control one hardware output.

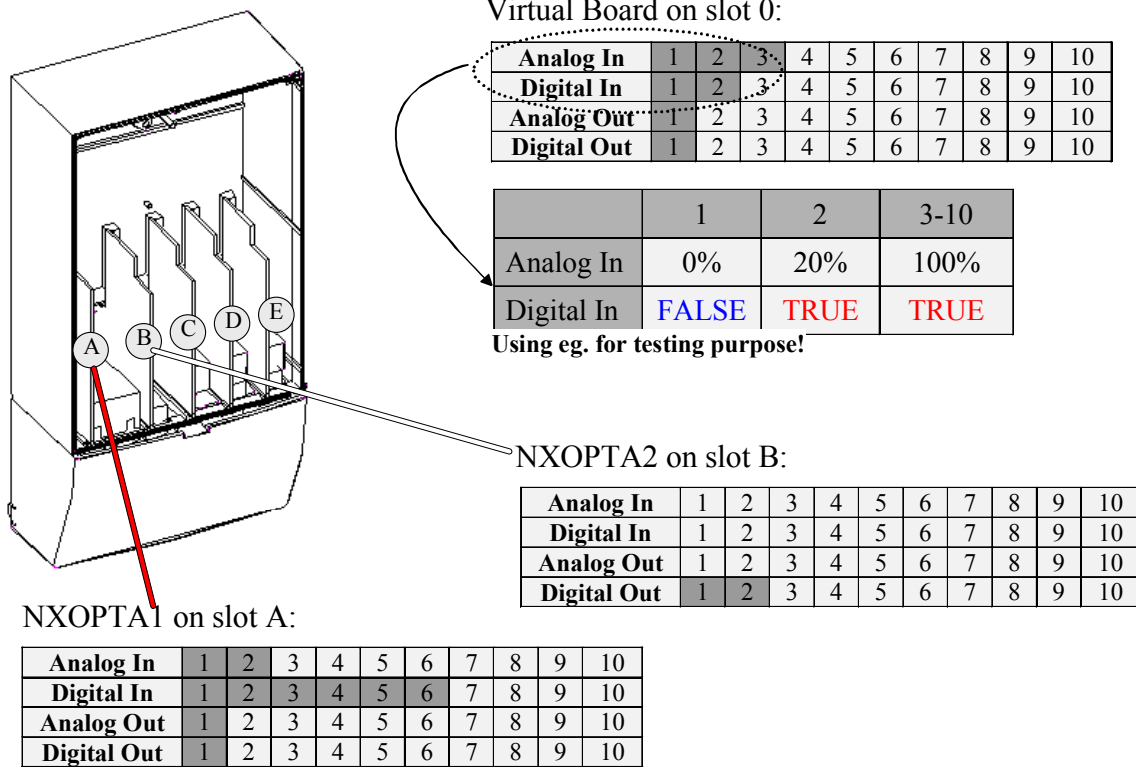

Figure 4. Capacity of an interface board

Each option board can have up to 10 inputs and/or outputs of each type, but all 10 are not necessarily used on every board (the amount of terminals causes limitations).

Figure 4 describes the standard option board.

**Available inputs and outputs on Vacon basic option boards**

OPT-A1 in slot A:

- two analogue inputs available, named A.1 and A.2 when programming
- six digital inputs, named A.1 to A.6 when programming
- one analogue output, named A.1 when programming
- one digital output, named A.1 when programming

OPT-A2 in slot B:

- two digital outputs available, named B.1 and B.2 when programming

**Note:** In spite of the terminal type (input/output, digital/analogue), the naming principle is the same for all terminals on the same board. Therefore, the first analogue input on board OPT-A1 is named A.1, but the first digital output on board OPT-A1 is also named A.1.

Functions that are not used are programmed to the virtual board in slot 0. Depending of the needed value or level the number is set to 1, 2 or 3.



## 0.5 Defining an input for a certain function on keypad

Connecting a certain function (input/output) to a certain input/output is done by giving the parameter an appropriate value. The value is formed of the *Board slot* on the Vacon NX control board (see the product's User's Manual) and the *respective signal number*, see below.

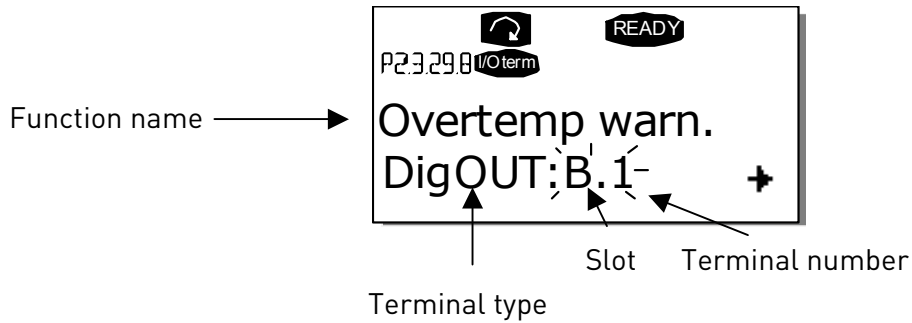

0.6 Circuit diagram of MultiMaster PFC and Advanced Level Control applications

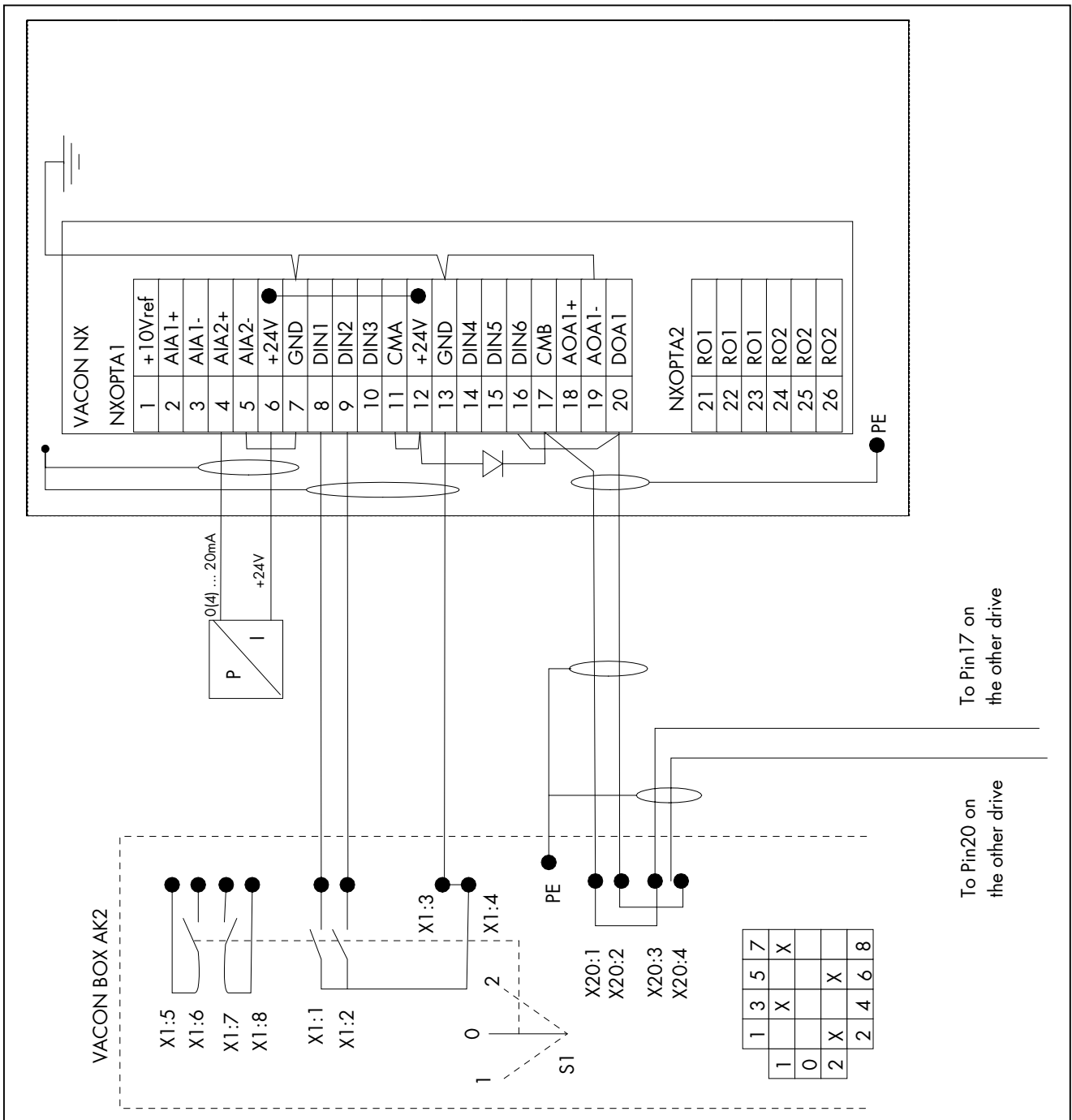

Figure 5. MultiMaster PFC Application, control diagram

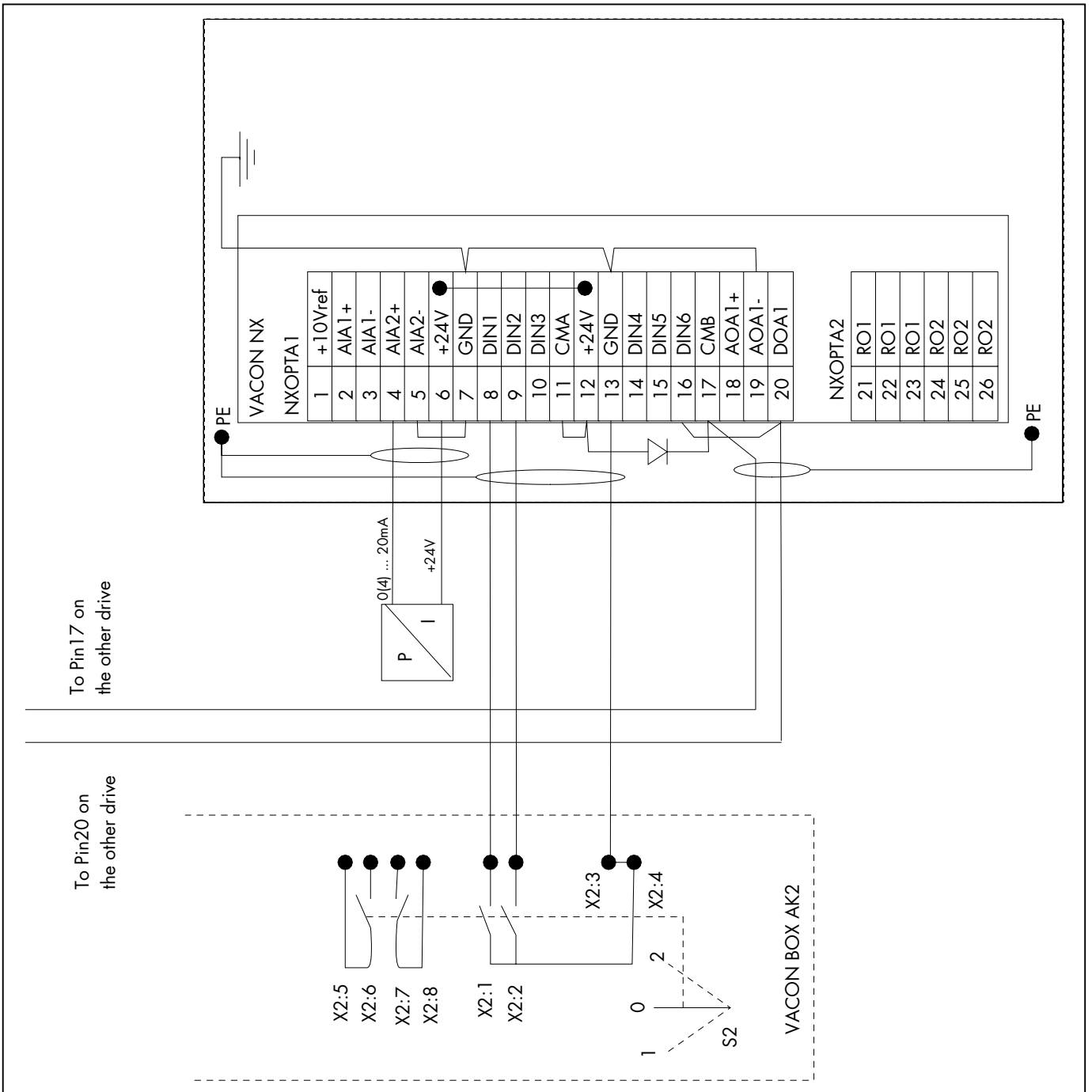

Figure 6. Advanced Level Control Application, control diagram

## 1. BASIC APPLICATION

### 1.1 Introduction

The Basic Application is easy and flexible to use due to its versatile fieldbus features. It is the default setting on delivery from the factory. Otherwise select the Basic Application in menu **M6** on page *S6.2*. See the product's User's Manual.

Digital input DIN3 is programmable.

The parameters of the Basic Application are explained in Chapter 5 of this manual. The explanations are arranged according to the individual ID number of the parameter.

### 1.2 Motor protection functions in the Basic Application

The Basic Application provides almost all the same protection functions as the other applications:

- External fault protection
- Input phase supervision
- Undervoltage protection
- Output phase supervision
- Earth fault protection
- Motor thermal protection
- Thermistor fault protection
- Fieldbus fault protection
- Slot fault protection

Unlike the other applications, the Basic Application does not provide any parameters for choosing the response function or limit values for the faults. The motor thermal protection is explained in more detail on page 105.

1.3 Control I/O

Reference potentiometer,  
1...10 kΩ

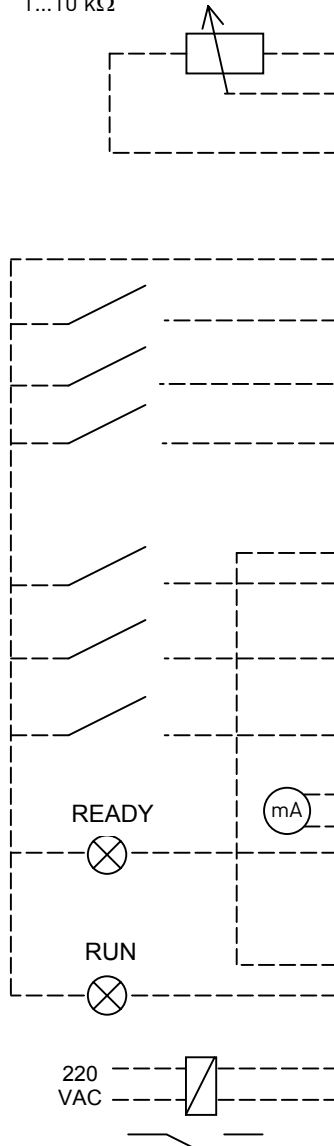



OPT-A1		
Terminal	Signal	Description
1	+10V <sub>ref</sub>	Reference output Voltage for potentiometer, etc.
2	AI1+	Analogue input, voltage range 0–10V DC Voltage input frequency reference
3	AI1-	I/O Ground Ground for reference and controls
4	AI2+	Analogue input, current range 0–20mA Current input frequency reference
5	AI2-	
6	+24V	Control voltage output Voltage for switches, etc. max 0.1 A
7	GND	I/O ground Ground for reference and controls
8	DIN1	Start forward Contact closed = start forward
9	DIN2	Start reverse Contact closed = start reverse
10	DIN3	External fault input (programmable) Contact open = no fault Contact closed = fault
11	CMA	Common for DIN 1–DIN 3 Connect to GND or +24V
12	+24V	Control voltage output Voltage for switches (see #6)
13	GND	I/O ground Ground for reference and controls
14	DIN4	Multi-step speed select 1 DIN4   DIN5   Frequency ref. Open   Open   Ref. U <sub>in</sub> Closed   Open   Multi-step ref.1 Open   Closed   Multi-step ref.2 Closed   Closed   RefMax
15	DIN5	
16	DIN6	
17	CMB	
18	A01+	Output frequency Programmable
19	A01-	Analogue output Range 0–20 mA/R <sub>L</sub> , max. 500Ω
20	D01	Digital output READY Programmable Open collector, I <sub>s</sub> ≤50mA, U <sub>s</sub> ≤48 VDC
OPT-A2		
21	R01	Relay output 1 RUN
22	R01	
23	R01	
24	R02	Relay output 2 FAULT
25	R02	
26	R02	

Table 1. Basic application default I/O configuration.

**Note:** See jumper selections below.  
More information in the product's User's Manual.

**Jumper block X3:  
CMA and CMB grounding**

-  CMB connected to GND  
CMA connected to GND
-  CMB isolated from GND  
CMA isolated from GND
-  CMB and CMA internally connected together, isolated from GND

 = Factory default

1.4 Control signal logic in Basic Application

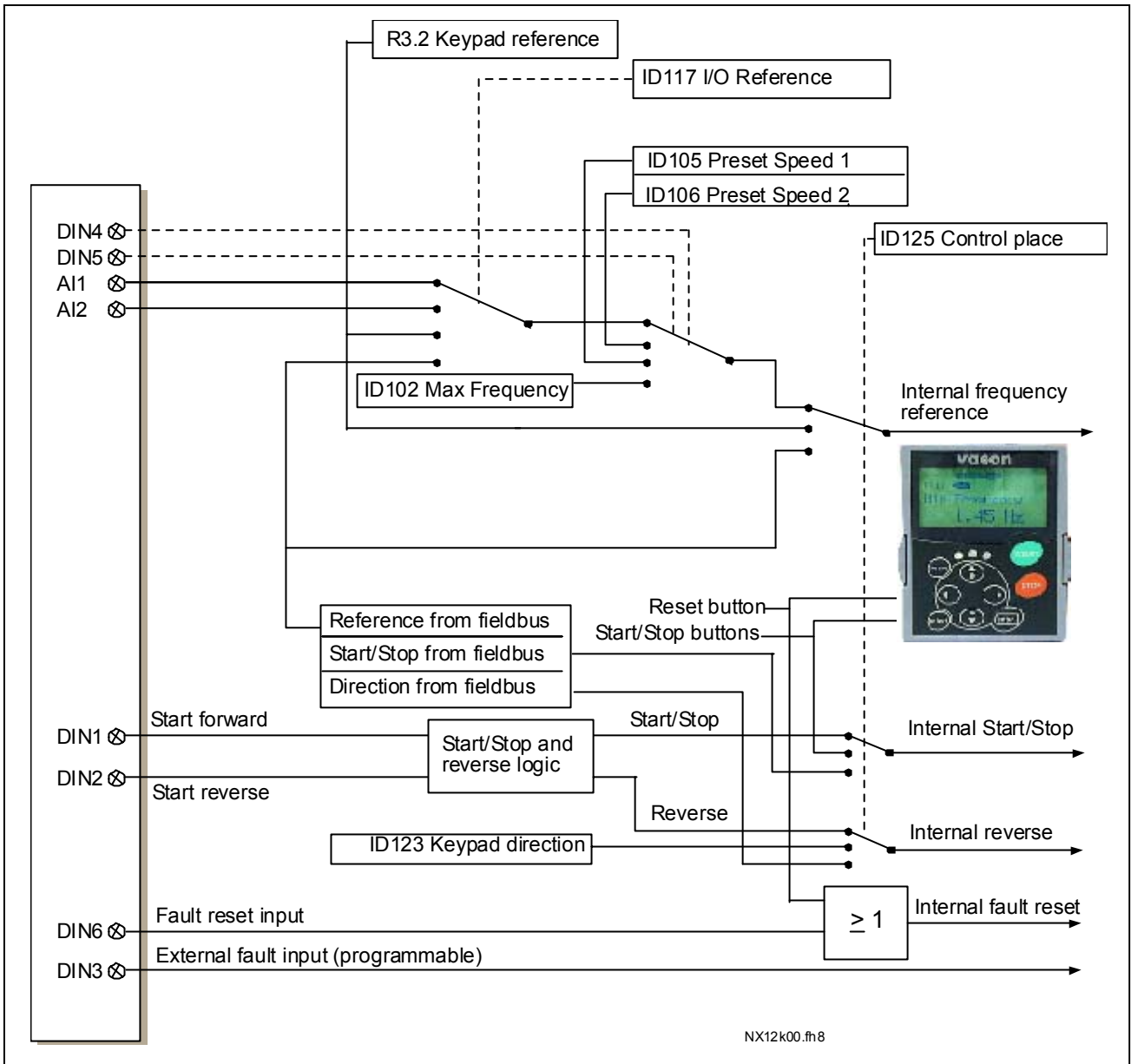



Figure 7. Control signal logic of the Basic Application

## 1.5 Basic Application – Parameter lists

On the next pages you will find the lists of parameters within the respective parameter groups. Each parameter includes a link to the respective parameter description. The parameter descriptions are given on pages 77 to 122.

### Column explanations:

Code	= Location indication on the keypad; Shows the operator the present parameter number
Parameter	= Name of parameter
Min	= Minimum value of parameter
Max	= Maximum value of parameter
Unit	= Unit of parameter value; Given if available
Default	= Value preset by factory
Cust	= Customer's own setting
ID	= ID number of the parameter

 = Parameter value can only be changed after the frequency converter has been stopped.

### 1.5.1 Monitoring values (Control keypad: menu M1)

The monitoring values are the actual values of parameters and signals as well as statuses and measurements. Monitoring values cannot be edited.

See the product's User's Manual for more information.

Code	Parameter	Unit	ID	Description
V1.1	Output frequency	Hz	1	Output frequency to motor
V1.2	Frequency reference	Hz	25	Frequency reference to motor control
V1.3	Motor speed	rpm	2	Motor speed in rpm
V1.4	Motor current	A	3	
V1.5	Motor torque	%	4	Calculated shaft torque
V1.6	Motor power	%	5	Motor shaft power
V1.7	Motor voltage	V	6	
V1.8	DC link voltage	V	7	
V1.9	Unit temperature	°C	8	Heatsink temperature
V1.10	Motor temperature	%	9	Calculated motor temperature
V1.11	Voltage input	V	13	AI1
V1.12	Current input	mA	14	AI2
V1.13	DIN1, DIN2, DIN3		15	Digital input statuses
V1.14	DIN4, DIN5, DIN6		16	Digital input statuses
V1.15	DO1, RO1, RO2		17	Digital and relay output statuses
V1.16	Analogue I <sub>out</sub>	mA	26	AO1
M1.17	Multimonitoring items			Displays three selectable monitoring values

Table 2. Monitoring values

## 1.5.2 Basic parameters (Control keypad: Menu M2 → G2.1)

Code	Parameter	Min	Max	Unit	Default	Cust	ID	Note
P2.1	Min frequency	0,00	Par. 2.2	Hz	0,00		101	
P2.2	Max frequency	Par. 2.1	320,00	Hz	50,00		102	<b>NOTE:</b> If $f_{max}$ > than the motor synchronous speed, check suitability for motor and drive system
P2.3	Acceleration time 1	0,1	3000,0	s	3,0		103	
P2.4	Deceleration time 1	0,1	3000,0	s	3,0		104	
P2.5	Current limit	$0,1 \times I_H$	$2 \times I_H$	A	$I_L$		107	
P2.6	Nominal voltage of the motor	180	690	V	NX2: 230V NX5: 400V NX6: 690V		110	Check the rating plate of the motor
P2.7	Nominal frequency of the motor	8,00	320,00	Hz	50,00		111	Check the rating plate of the motor
P2.8	Nominal speed of the motor	24	20 000	rpm	1440		112	Check the rating plate of the motor The default applies for a 4-pole motor and a nominal size frequency converter.
P2.9	Nominal current of the motor	$0,1 \times I_H$	$2 \times I_H$	A	$I_H$		113	Check the rating plate of the motor.
P2.10	Motor cosφ	0,30	1,00		0,85		120	Check the rating plate of the motor
P2.11	Start function	0	1		0		505	0=Ramp 1=Flying start
P2.12	Stop function	0	3		0		506	0=Coasting 1=Ramp 2=Ramp+Run enable coast 3=Coast+Run enable ramp
P2.13	U/f optimisation	0	1		0		109	0=Not used 1=Automatic torque boost
P2.14	I/O reference	0	3		0		117	0=AI1 1=AI2 2=Keypad 3=Fieldbus
P2.15	Current reference offset	0	1		1		302	0= No offset, 0—20mA 1= Offset, 4mA—20 mA
P2.16	Analogue output function	0	8		1		307	0=Not used 1=Output freq. (0— $f_{max}$ ) 2=Freq. reference (0— $f_{max}$ ) 3=Motor speed (0—Motor nominal speed) 4=Output current (0— $I_{nMotor}$ ) 5=Motor torque (0— $T_{nMotor}$ ) 6=Motor power (0— $P_{nMotor}$ ) 7=Motor voltage (0— $U_{nMotor}$ ) 8=DC-link volt (0—1000V)
P2.17	DIN3 function	0	7		1		301	0=Not used 1=Ext. fault, closing cont. 2=Ext. fault, opening cont. 3=Run enable, cc 4=Run enable, oc 5=Force cp. to IO 6=Force cp. to keypad 7=Force cp. to fieldbus
P2.18	Preset speed 1	0,00	Par. 2.1.2	Hz	0,00		105	Speeds preset by operator
P2.19	Preset speed 2	0,00	Par. 2.1.2	Hz	50,00		106	Speeds preset by operator
P2.20	Automatic restart	0	1		0		731	0=Disabled 1=Enabled

Table 3. Basic parameters G2.1



### 1.5.3 Keypad control (Control keypad: Menu M3)

The parameters for the selection of control place and direction on the keypad are listed below. See the Keypad control menu in the product's User's Manual.

Code	Parameter	Min	Max	Unit	Default	Cust	ID	Note
P3.1	Control place	1	3		1		125	1=/0 terminal 2=Keypad 3=Fieldbus
R3.2	Keypad reference	Par. 2.1	Par. 2.2	Hz				
P3.3	Direction (on keypad)	0	1		0		123	Reverse request activated from the panel
R3.4	Stop button	0	1		1		114	0=Limited function of Stop button 1=Stop button always enabled

Table 4. Keypad control parameters, M3

### 1.5.4 System menu (Control keypad: Menu M6)

For parameters and functions related to the general use of the frequency converter, such as application and language selection, customised parameter sets or information about the hardware and software, see the product's User's Manual.

### 1.5.5 Expander boards (Control keypad: Menu M7)

The **M7** menu shows the expander and option boards attached to the control board and board-related information. For more information, see the product's User's Manual.

## 2. MULTIMASTER PFC APPLICATION

### 2.1 Brief description of MultiMaster PFC application

With the MultiMaster PFC application, you can build a system where up to 3 drives handle the regulation. The internal PID controller regulates the drives. The drives are operating in a chained control where one of them is always the leading drive. This way they can together control a system with several devices in parallel.

When you have the application package loaded in your Vacon drive you can select the MultiMaster PFC application in system menu, **M6** with parameter *S6.2*.

### 2.2 Functionality

The application is designed to achieve an even wear of the pumps connected to the motors/ drives by regularly changing the regulating order of the drives. The application supports the maximum of 3 pumps, fans or compressors to work in parallel. One drive is leading and regulating (PID) while the others are either stand-by or running at the speed that produces the nominal flow in the system.

Connections to/ from and between the drives are easily made. The drive is connected directly to its own motor/ pump. There is neither need for additional contactors nor any soft starting devices. An ordinary pair cable is used for the communications between drives.

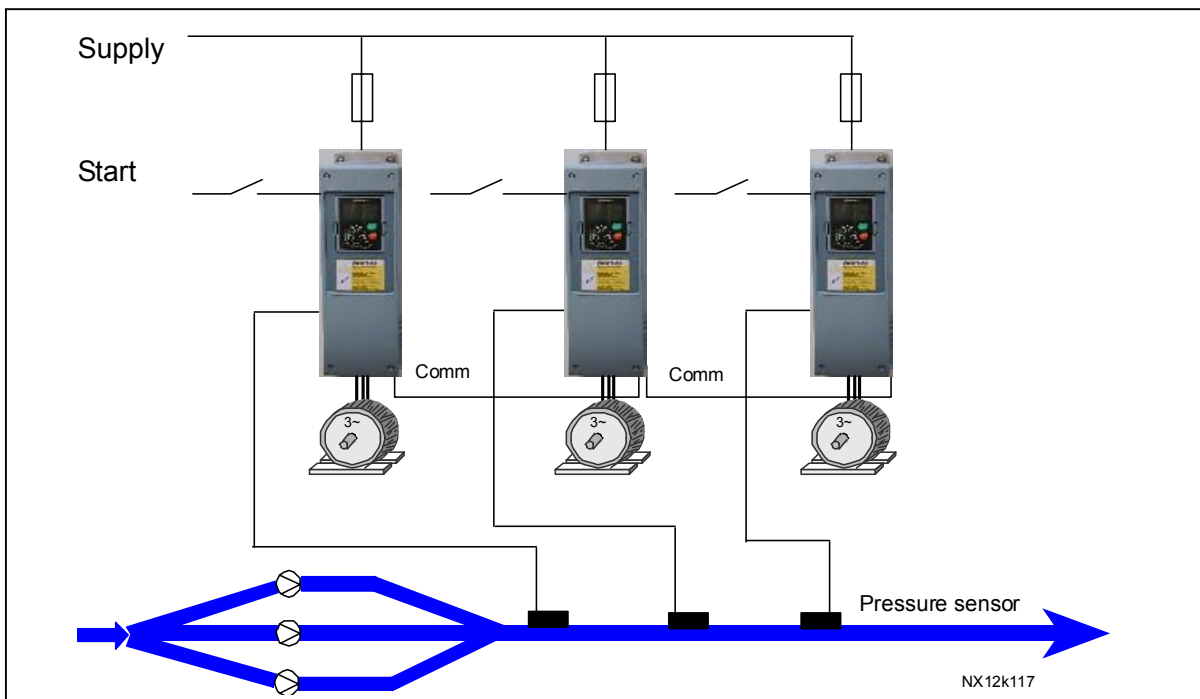

Figure 8. Operating principle of MultiMaster PFC system

### 2.3 Chained control and autochange

When the leading drive notices a demand for more capacity, but cannot produce this by itself, it will send a request for NEXT START on the communication line. It will lock itself at nominal producing speed and the next drive will start controlling.

When the leading drive notices that there is too much capacity (running at min. producing frequency) AND there are units running at nominal producing speed, then it will put itself to Stand-by mode and the drive running at nominal producing speed will start controlling. If there are several drives running at nominal producing speed, the one with highest priority will start to regulate.

If there are NO drives running at nominal producing speed when the drive notices the overcapacity, the drive will go into Sleeping mode.

The Vacon drives in the system will automatically alternate operating as the leading drive to equalize the wear of the devices in the system.

The drive is counting time for the autochange event when is running. The time to run before the autochange shall occur can be set by the user.

When the drive reaches the set time, it will stop regulating and then slowly ramp down and stop. The other drives will notice that the drive is stopping for the autochange event and the next drive will take up the control.

When all drives in the installation have performed their leading role the timers of all drives are reset. The "reset" command does not necessarily set the counters to zero, but the counter value is decreased by the autochange value set by the user. (Default value is 48h)

#### Examples:

Autochange time:	48h
Running hours:	64h
Running hours after reset:	$64-48=16h$

The counter value can increase over 48h (autochange value) if this drive has been running while the others have been in the leading role. This way the running times of the drives are equalized.

2.4 Control I/O

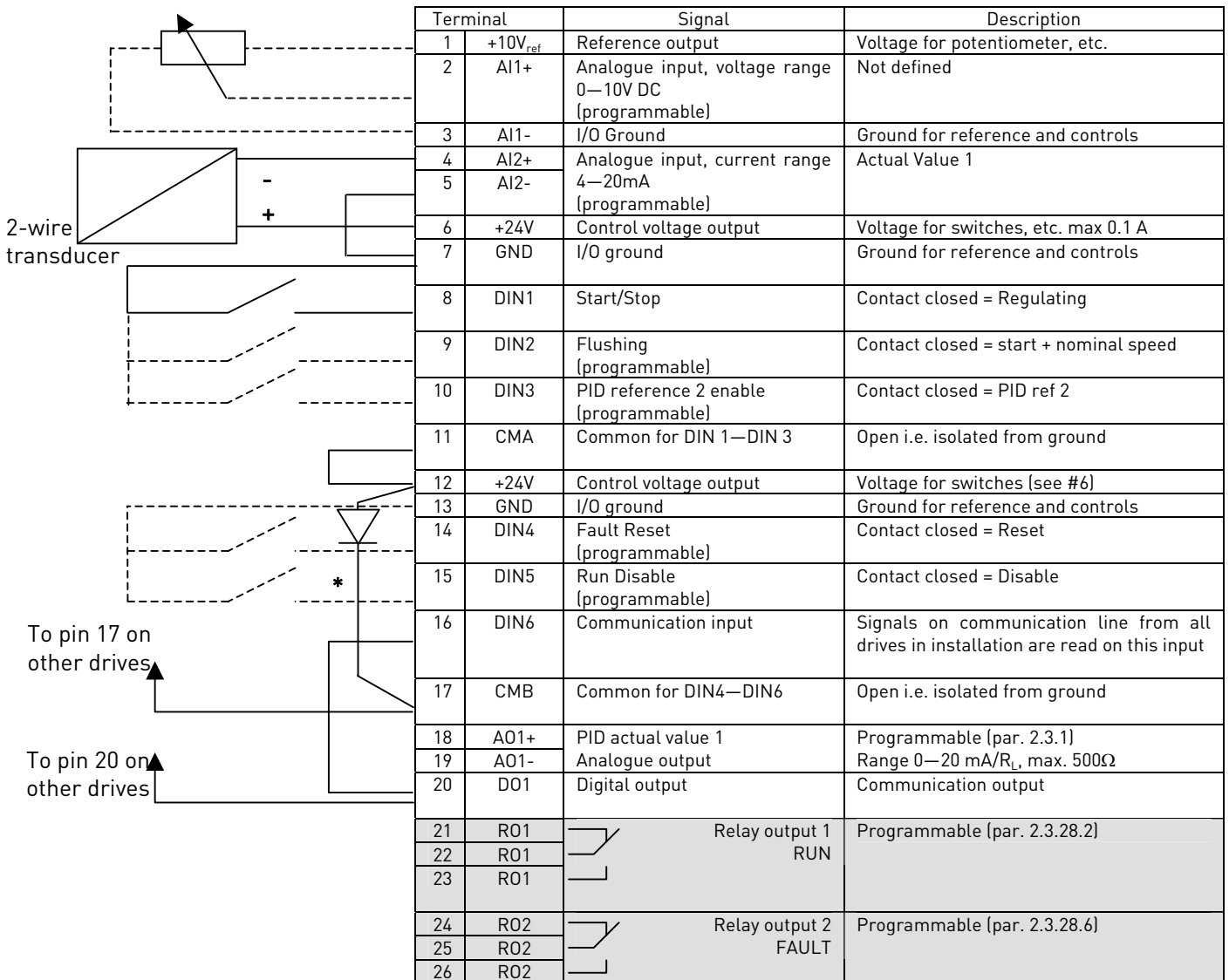

Figure 9. I/O configuration for the MultiMaster PFC application

\* = 1N4004

The diode is needed to prevent backward supply of 24V from other drives.

**NOTE!** All digital inputs are used with negative logic (0V is active). Jumper X3 has to be connected so that CMA and CMB are isolated from ground, i.e. OPEN. See Figure 10 below.

Digital inputs DIN3, DIN4, DIN5 are freely programmable. So is the digital output DO1 which, together with the digital input DIN6, is reserved for the communication between drives.

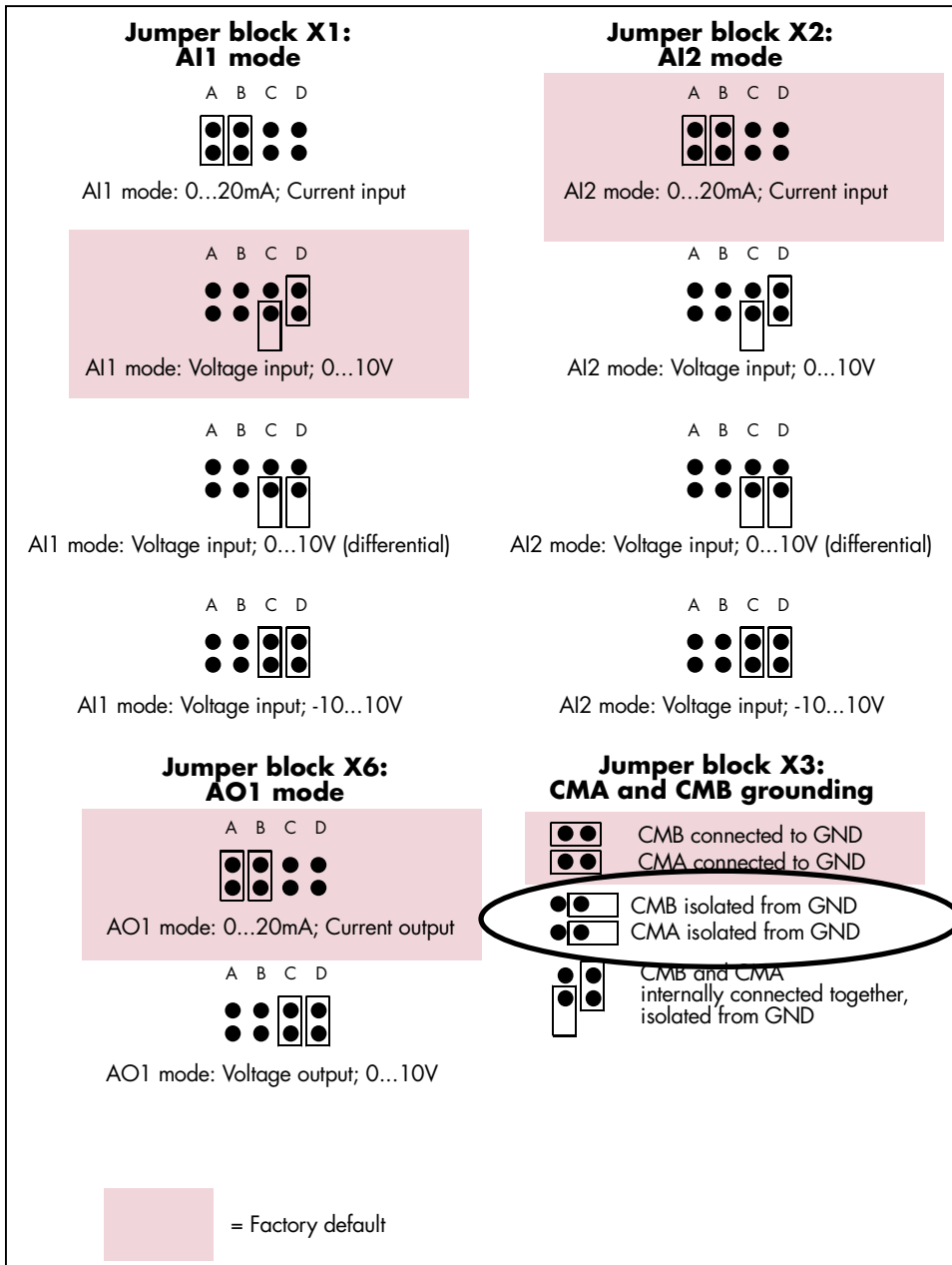



Figure 10. Jumper selection for OPT-A1

See also the product's User's manual for more details.

 <b>NOTE</b>	<p>If you change the AI/AO signal content also remember to change the corresponding board parameter in menu M7.</p>
--	---

2.5 Control signal logic in MultiMaster PFC Application

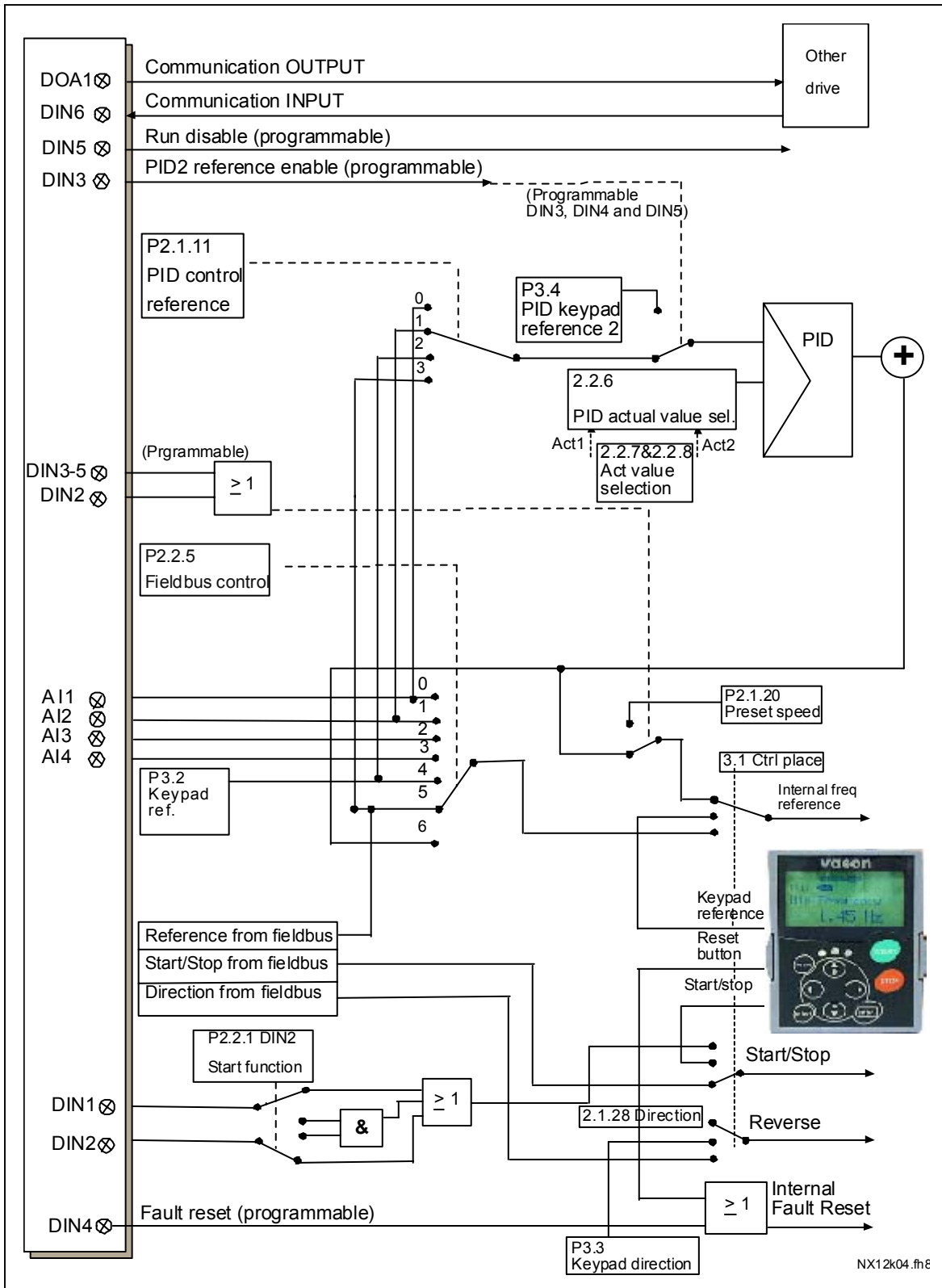



Figure 11. Control signal logic in MultiMaster PFC Application

## 2.6 MultiMaster PFC Application – Parameter lists

On the next pages you will find the lists of parameters within the respective parameter groups. Each parameter includes a link to the respective parameter description. The parameter descriptions are given on pages 77 to 122.

### Column explanations:

Code	=	Location indication on the keypad; Shows the operator the present param. number
Parameter	=	Name of parameter
Min	=	Minimum value of parameter
Max	=	Maximum value of parameter
Unit	=	Unit of parameter value; Given if available
Default	=	Value preset by factory
Cust	=	Customer's own setting
ID	=	ID number of the parameter (used with PC tools)
	=	Parameter value can only be changed after the FC has been stopped.
	=	In parameter row: Use TTF method to program these parameters

### 2.6.1 Monitoring values (Control keypad: menu M1)

The monitoring values are the actual values of parameters and signals as well as statuses and measurements. Monitoring values cannot be edited.

See the product's User's Manual for more information.

Code	Parameter	Unit	ID	Description
V1.1	Output frequency	Hz	1	Output frequency to motor
V1.2	Frequency reference	Hz	25	Frequency reference to motor control
V1.3	Motor speed	rpm	2	Motor speed in rpm
V1.4	Motor current	A	3	
V1.5	Motor torque	%	4	Calculated shaft torque
V1.6	Motor power	%	5	Motor shaft power
V1.7	Motor voltage	V	6	
V1.8	DC link voltage	V	7	
V1.9	Unit temperature	°C	8	Heat sink temperature
V1.10	Voltage input	V	13	AI1
V1.11	Current input	mA	14	AI2
V1.12	Analogue input			AI3
V1.13	Analogue input			AI4
V1.14	DIN1, DIN2, DIN3		15	Digital input statuses
V1.15	DIN4, DIN4, DIN6		16	Digital input statuses
V1.16	Analogue I <sub>out</sub>	mA	26	AO1
V1.17	PID Reference	%	20	In percent of the maximum frequency
V1.18	PID Actual value	%	21	In percent of the max actual value
V1.19	PID Error value	%	22	In percent of the max error value
V1.20	PID Output	%	23	In percent of the max output value
V1.21	Period running hour	h	1503	Running hours of this period
V1.22	Period running min.	min	1504	Running minutes of this period
V1.23	Drive status		1511	0=Off 1=Communication line error 2=Stand-by 3=Regulating 4=Nom.prod. 5=Sleeping
V1.24	Status Word		1543	Give the Status Word to Vacon personnel in case of problems with running the application
V1.25	Actual value special display		1547	Actual value special display See par. ID1544 to 1546
G1.26	Monitoring items			Displays three selectable monitoring values

Table 5. Monitoring values



## 2.6.2 Basic parameters (Control keypad: Menu M2 → G2.1)

Code	Parameter	Min	Max	Unit	Default	Cust	ID	Note
P2.1.1	Null producing limit	0,00	Par. 2.1.2	Hz	15,00		101	Min output freq / Sleep freq/ Change freq
P2.1.2	Max producing limit	Par. 2.1.1	320,00	Hz	50,00		102	<b>NOTE:</b> If $f_{max}$ > than the motor synchronous speed, check suitability for motor and drive system
P2.1.3	Acceleration time 1	0,1	3000,0	s	3,0		103	
P2.1.4	Deceleration time 1	0,1	3000,0	s	3,0		104	
P2.1.5	Current limit	$0,1 \times I_H$	$2 \times I_H$	A	$I_L$		107	
P2.1.6	Nominal voltage of the motor	180	690	V	NX2: 230V NX5: 400V NX6: 690V		110	
P2.1.7	Nominal frequency of the motor	8,00	320,00	Hz	50,00		111	Check the rating plate of the motor
P2.1.8	Nominal speed of the motor	24	20 000	rpm	1440		112	The default applies for a 4-pole motor and a nominal size frequency converter.
P2.1.9	Nominal current of the motor	$0,1 \times I_H$	$2 \times I_H$	A	$I_H$		113	Check the rating plate of the motor.
P2.1.10	Motor cosφ	0,30	1,00		0,85		120	Check the rating plate of the motor
P2.1.11	PID controller reference signal (Place A)	0	4		2		332	<b>0</b> =Anal.volt. input (#2–3) <b>1</b> =Anal.curr.input (#4–5) <b>2</b> =PID ref from Keypad control page, par. 3.4 <b>3</b> =PID ref from fieldbus (FBProcessDataIN1)
P2.1.12	PID controller gain	0,0	1000,0	%	100,0		118	
P2.1.13	PID controller I-time	0,00	320,00	s	1,00		119	
P2.1.14	PID controller D-time	0,00	10,00	s	0,00		132	
P2.1.15	Next start delay	0	3600	s	5		1505	<b>**)</b>
P2.1.16	Own stop delay	0	3600	s	2		1512	<b>**)</b>
P2.1.17	Sleep delay	P2.1.16	3600	s	30		1017	
P2.1.18	Wake up level	0,00	100,00	%	30,00		1018	
P2.1.19	Wake up function	0	3		0		1019	<b>0</b> =Wake-up at fall below wake up level (2.1.18, % of Actual value max) <b>1</b> =Wake-up at exceeded wake up level (2.1.18, % of Actual value max) <b>2</b> =Wake-up at fall below wake up level (2.1.18, % of PID ref value max) <b>3</b> =Wake-up at exceeded wake up level (2.1.18, % of PID ref value max)
P2.1.20	Preset speed	0,00	Par. 2.1.2	Hz	50,00		124	
P2.1.21	Own ID number	0	3		0		1500	The specific ID number of the drive, in the specific installation
P2.1.22	Number of drives	1	3	Pcs	2		1502	Total amount of drives in the installation
P2.1.23	Interval time	0	170	h	48		1501	The time after which the autochange will occur <b>0</b> = 5 minutes (for commissioning) <b>170</b> = Autochange is bypassed
P2.1.24	Reference step	0,00	100,00	%	0,00		1506	

P2.1.25	Constant production frequency	Par2.1.1	Par2.1.2	Hz	0,00		1513	
P2.1.26	Error value limit high	100	500	%	120		1554	
P2.1.27	Error value limit low	100	Par.2.1.29	%	105		1553	
P2.1.28	Direction	0	1		0		1548	Reverse direction
P2.1.29	Special display min	0	30000		0		1544	
P2.1.30	Special display max	0	30000		100		1545	
P2.1.31	Special display dec	0	4		1		1546	
P2.1.32	Special display unit	0	28		4		1549	<ul style="list-style-type: none"> <li>0=Not Used</li> <li>1=%</li> <li>2=°C</li> <li>3=m</li> <li>4=bar</li> <li>5=mbar</li> <li>6=Pa</li> <li>7=kPa</li> <li>8=PSI</li> <li>9=m /s</li> <li>10=l/s</li> <li>11=l/min</li> <li>12=l/h</li> <li>13=m3/s</li> <li>14=m3/min</li> <li>15=m3/h</li> <li>16=°F</li> <li>17=ft</li> <li>18=gal/s (GPS)</li> <li>19=gal/min (GPM)</li> <li>20=gal/h (GPH)</li> <li>21=ft3/s (CFS)</li> <li>22=ft3/min (CFM)</li> <li>23=f3/h (CFH)</li> <li>24=A</li> <li>25=V</li> <li>26=W</li> <li>27=kW</li> <li>28=Hp</li> </ul>

Table 6. Basic parameters G2.1

\*\*) If BOTH 2.1.15 and 2.1.16 are "0", only one drive is handling all the pumping capacity. I.e. auxiliary drives are not requested. The autochange function works, however.

### 2.6.3 Input signals (Control keypad: Menu M2 → G2.2)

Code	Parameter	Min	Max	Unit	Default	Cust	ID	Note
P2.2.1	DIN2 Start function	0	1		0		1508	0=DIN2 alone starts the drive at "pre-set speed" 1= Both DIN1 and DIN2 has to be activated before the drive will start and run at the speed set in P2.1.20
P2.2.2	DIN3 function	0	12		11		301	0=Not used 1=External fault cc 2=External fault oc 3=Run enable 4= CP: I/O terminal 5= CP: Keypad 6= CP: Fieldbus 7=Pre set speed 8=Fault reset 9=Acc./Dec.operation prohibit 10= DC braking command 11= Enable PID reference 2 12 = Run disable
P2.2.3	DIN4 function	0	12		8		1509	See above
P2.2.4	DIN5 function	0	12		12		330	See above
P2.2.5	Fieldbus control reference selection	1	6		5		122	1=AI2 2=AI3 3=AI4 4=Panel reference 5=FB reference 6=PID controller
P2.2.6	Actual value selection	0	7		0		333	0=Actual value 1 1=Actual 1 + Actual 2 2=Actual 1 - Actual 2 3=Actual 1 * Actual 2 4=Min[Actual 1, Actual 2] 5=Max[Actual 1, Actual 2] 6=Mean[Actual1, Actual2] 7=.Sqrt (Act1) + Sqrt (Act2)
P2.2.7	Actual value 1 input	0	5		2		334	0=Not used 1=AI1 signal (c-board) 2=AI2 signal (c-board) 3=AI3 signal 4=AI4 signal 5=Fieldbus (FBProcessDataIN2)
P2.2.8	Actual value 2 input	0	5		0		335	0=Not used 1=AI1 signal (c-board) 2=AI2 signal (c-board) 3=AI3 signal 4=AI4 signal 5=Fieldbus (FBProcessDataIN3)
P2.2.9	Actual value 1 minimum scale	-320,00	320,00	%	0,00		336	0=No minimum scaling
P2.2.10	Actual value 1 maximum scale	-320,00	320,00	%	100,00		337	100=No maximum scaling
P2.2.11	Actual value 2 minimum scale	-320,00	320,00	%	0,00		338	0=No minimum scaling

P2.2.12	Actual value 2 maximum scale	-320,00	320,00	%	100,00		339	100=No maximum scaling
P2.2.13	AI1 Signal select	0			A.1		1532	
P2.2.14	AI1 signal range	0	2		0		320	0=Signal range 0—10V 1=Signal range 2—10V 2=Custom range
P2.2.15	AI1 custom minimum setting	0,00	100,00	%	0,00		321	
P2.2.16	AI1 custom maximum setting	0,00	100,00	%	100,00		322	
P2.2.17	AI1 inversion	0	1		0		323	0=Not inverted 1=Inverted
P2.2.18	AI1 filter time	0,00	10,00	s	0,10		324	0=No filtering
P2.2.19	AI2 Signal select	0			A.2		1533	
P2.2.20	AI2 signal range	0	2		1		325	0=0—20 mA 1=4—20 mA 2=Customised
P2.2.21	AI2 custom minimum setting	0,00	100,00	%	0,00		326	
P2.2.22	AI2 custom maximum setting	0,00	100,00	%	100,00		327	
P2.2.23	AI2 inversion	0	1		0		328	0=Not inverted 1=Inverted
P2.2.24	AI2 filter time	0,00	10,00	s	0,10		329	0=No filtering
P2.2.25	PID minimum limit	-100,00	Par. 2.2.29	%	0,00		359	
P2.2.26	PID maximum limit	Par. 2.2.28	100,00	%	100,00		360	
P2.2.27	Error value inversion	0	1		0		340	0=No inversion 1=Inversion
P2.2.28	PID reference rising time	0,1	100,0	s	5,0		341	
P2.2.29	PID reference falling time	0,1	100,0	s	5,0		342	
P2.2.30	Easy changeover	0	1		0		366	0=Keep reference 1=Copy actual reference
P2.2.31	AI3 Signal select	0			0.1		141	
P2.2.32	AI3 Signal range	0	1		1		143	
P2.2.33	AI3 inversion	0	1		0		151	0=Not inverted 1=Inverted
P2.2.34	AI3 filter time	0,00	10,00	s	0,10		142	0=No filtering
P2.2.35	AI4 Signal select	0			0.1		152	
P2.2.36	AI4 Signal range	0	1		1		154	
P2.2.37	AI4 inversion	0	1		0		162	0=Not inverted 1=Inverted
P2.2.38	AI4 filter time	0,00	10,00	s	0,10		153	0=No filtering

Table 7. Input signals, G2.2

CP=control place  
cc=closing contact  
oc=opening contact

### 2.6.4 Output signals (Control keypad: Menu M2 → G2.3)

Code	Parameter	Min	Max	Unit	Default	Cust	ID	Note
P2.3.1	Analogue output function	0	13		10		307	0=Not used 1=Output freq. (0– $f_{max}$ ) 2=Freq. reference (0– $f_{max}$ ) 3=Motor speed (0–Motor nominal speed) 4=Output current (0– $I_{nMotor}$ ) 5=Motor torque (0– $T_{nMotor}$ ) 6=Motor power (0– $P_{nMotor}$ ) 7=Motor voltage (0– $U_{nMotor}$ ) 8=DC-link volt (0– $U_{nMotor}$ ) 9=PID controller ref. value 10=PID contr. act. value 1 11=PID contr. act. value 2 12=PID contr. error value 13=PID controller output
P2.3.2	Analogue output filter time	0,00	10,00	s	1,00		308	
P2.3.3	Analogue output inversion	0	1		0		309	0=Not inverted 1=Inverted
P2.3.4	Analogue output minimum	0	1		0		310	0=0 mA 1=4 mA
P2.3.5	Analogue output scale	10	1000	%	100		311	
P2.3.6	Output frequency limit 1 supervision	0	2		0		315	0=No limit 1=Low limit supervision 2=High limit supervision
P2.3.7	Output frequency limit 1; Supervised value	0,00	Par. 2.1.2	Hz	0,00		316	
P2.3.8	Output frequency limit 2 supervision	0	2		0		346	0=No limit 1=Low limit supervision 2=High limit supervision
P2.3.9	Output frequency limit 2; Supervised value	0,00	Par. 2.1.2	Hz	0,00		347	
P2.3.10	Torque limit supervision	0	2		0		348	0=Not used 1=Low limit supervision 2=High limit supervision
P2.3.11	Torque limit supervision value	0,0	300,0	%	100,0		349	
P2.3.12	FC temperature supervision	0	2		0		354	0=Not used 1=Low limit 2=High limit
P2.3.13	FC temperature supervised value	-10	100	°C	40		355	
P2.3.14	Actual value supervision to relay	0	100,00	%	0,00		1541	
P2.3.15	Actual value over / under sup value to relay	0	2		0		1542	0=Not used 1=Over supervised value 2=Under supervised value
P2.3.16	lout2 signal	0			0.1		471	
P2.3.17	lout2 content	0	13		7		472	
P2.3.18	lout2 filter time	0,00	10,00	s	1,00		473	
P2.3.19	lout2 invert	0	1		0		474	
P2.3.20	lout2 minimum	0	1		0		475	
P2.3.21	lout2 scale	10	1000	%	0		476	
P2.3.22	lout3 signal	0			0.1		1534	
P2.3.23	lout3 content	0	13		0		1535	
P2.3.24	lout3 filter time	0,00	10,00	s	0,00		1536	

P2.3.25	<a href="#">lout3 invert</a>	0	1		0		1527	
P2.3.26	<a href="#">lout3 minimum</a>	0	1		0		1538	
P2.3.27	<a href="#">lout3 scale</a>	10	1000	%	0		1539	

Table 8. Output signals, G2.3

### 2.6.5 Delayed Output signals R01 and R02 (Control keypad: Menu M2 → G2.3.28)

Code	Parameter	Min	Max	Unit	Default	Cust	ID	Note
P2.3.28.1	<a href="#">R01 Signal</a>	0			B.1		1524	
P2.3.28.2	<a href="#">R01 Content</a>		16		2		1525	0=Not used 1=Ready 2=Run 3=Fault 4=Fault inverted 5=Warning 6=External fault or warning 7=Reference fault or warning 8=Vacon overheat warning 9=Preset speed 10=Output freq. limit sup. 1 11=Output freq. limit sup. 2 12=Thermistor fault/warning 13=Torque limit supervision 14=Motor thermal fault warn 15=Motor reg. activated 16=Act. value limit superv.
P2.3.28.3	<a href="#">R01 On delay</a>	0,00	320,00	s	0,00		1526	
P2.3.28.4	<a href="#">R01 Off delay</a>	0,00	320,00	s	0,00		1527	
P2.3.28.5	<a href="#">R02 Signal</a>	0			B.2		1528	
P2.3.28.6	<a href="#">R02 Content</a>	0	16		3		1529	See P2.3.28.2
P2.3.28.7	<a href="#">R02 On delay</a>	0	320,00	s	0,00		1530	
P2.3.28.8	<a href="#">R02 Off delay</a>	0	320,00	s	0,00		1531	

Table 9. Delayed output signals, G2.3.28

### 2.6.6 Relay outputs (Control keypad: Menu M2 → G2.3.29)

Code	Parameter	Min	Max	Default	Cust	ID	Note
P2.3.29.1	Ready	0		A.1		432	
P2.3.29.2	Run	0		B.1		433	
P2.3.29.3	Fault	0		B.2		434	
P2.3.29.4	Fault, inverted	0		0.2		435	
P2.3.29.5	Warning	0		0.1		436	
P2.3.29.6	External fault/warning	0		0.1		437	
P2.3.29.7	AI ref fault/warning	0		0.1		438	
P2.3.29.8	Overtemp warning	0		0.1		439	
P2.3.29.9	Preset speed	0		0.1		443	
P2.3.29.10	FreqOut superv.limit1	0		0.1		447	
P2.3.29.11	FreqOut superv.limit2	0		0.1		448	
P2.3.29.12	Temp lim superv	0		0.1		450	
P2.3.29.13	Torq limit superv	0		0.1		451	
P2.3.29.14	Motor term fault/warn	0		0.1		452	
P2.3.29.15	Motor reg active	0		0.1		454	
P2.3.29.16	Actual value superv	0		0.1		1523	

Table 10. Relay output signals, G2.3.29

### 2.6.7 Drive control parameters (Control keypad: Menu M2 → G2.4)

Code	Parameter	Min	Max	Unit	Default	Cust	ID	Note
P2.4.1	Ramp 1 shape	0,0	10,0	s	0,1		500	0=Linear >0=S-curve ramp time
P2.4.2	Ramp 2 shape	0,0	10,0	s	0,0		501	0=Linear >0=S-curve ramp time
P2.4.3	Acceleration time 2	0,1	3000,0	s	5,0		502	
P2.4.4	Deceleration time 2	0,1	3000,0	s	5,0		503	
P2.4.5	Brake chopper	0	3		0		504	0=Disabled 1=Used and tested in Run state 2=External brake chopper 3=Used and tested in Ready state
P2.4.6	Start function	0	1		0		505	0=Ramp 1=Flying start
P2.4.7	Stop function	0	3		1		506	0=Coasting 1=Ramp 2=Ramp+Run enable coast 3=Coast+Run enable ramp
P2.4.8	DC braking current	0,00	$I_L$	A	$0,7 \times I_H$		507	
P2.4.9	DC braking time at stop	0,00	60,00	s	0,00		508	0=DC brake is off at stop
P2.4.10	Frequency to start DC braking during ramp stop	0,10	10,00	Hz	0,00		515	
P2.4.11	DC braking time at start	0,00	60,00	s	0,00		516	0=DC brake is off at start
P2.4.12	Flux brake	0	1		0		520	0=Off 1=On
P2.4.13	Flux braking current	0,00	$I_L$	A	$I_H$		519	

Table 11. Drive control parameters, G2.4

### 2.6.8 Prohibit frequency parameters (Control keypad: Menu M2 → G2.5)

Code	Parameter	Min	Max	Unit	Default	Cust	ID	Note
P2.5.1	Prohibit frequency range 1 low limit	0,0	Par. 2.5.2	Hz	0,0		509	0=Not used
P2.5.2	Prohibit frequency range 1 high limit	0,0	Par. 2.1.2	Hz	0,0		510	0=Not used
P2.5.3	Prohibit frequency range 2 low limit	0,0	Par. 2.5.4	Hz	0,0		511	0=Not used
P2.5.4	Prohibit frequency range 2 high limit	0,0	Par. 2.1.2	Hz	0,0		512	0=Not used
P2.5.5	Prohibit frequency range 3 low limit	0,0	Par. 2.5.6	Hz	0,0		513	0=Not used
P2.5.6	Prohibit frequency range 3 high limit	0,0	Par. 2.1.2	Hz	0,0		514	0=Not used
P2.5.7	Prohibit frequencies acc./dec. ramp scaling	0,1	10,0	Times	1,0		518	

Table 12. Prohibit frequency parameters, G2.5



### 2.6.9 Motor control parameters (Control keypad: Menu M2 → G2.6)

Code	Parameter	Min	Max	Unit	Default	Cust	ID	Note
P2.6.1	Motor control mode	0	1		0		600	0 = Frequency control 1 = Speed control
P2.6.2	U/f optimisation	0	1		0		109	0 = Not used 1 = Autom. torque boost
P2.6.3	U/f ratio selection	0	3		0		108	0 = Linear 1 = Squared 2 = Programmable 3 = Linear with flux optim.
P2.6.4	Field weakening point	30,00	320,00	Hz	50,00		602	
P2.6.5	Voltage at field weakening point	10,00	200,00	%	100,00		603	$n\% \times U_{nmot}$
P2.6.6	U/f curve midpoint frequency	0,00	par. P2.6.4	Hz	50,00		604	
P2.6.7	U/f curve midpoint voltage	0,00	100,00	%	100,00		605	$n\% \times U_{nmot}$ Parameter max. value = par. 2.6.5
P2.6.8	Output voltage at zero frequency	0,00	40,00	%	Varies		606	$n\% \times U_{nmot}$
P2.6.9	Switching frequency	1,0	16,0	kHz	Varies		601	Depends on kW
P2.6.10	Overvoltage controller	0	2		1		607	0=Not used 1=Used (no ramping) 2=Used (ramping)
P2.6.11	Undervoltage controller	0	2		1		608	0=Not used 1=Used (no ramping) 2=Used (ramping)

Table 13. Motor control parameters, G2.6

### 2.6.10 Protections (Control keypad: Menu M2 → G2.7)

Code	Parameter	Min	Max	Unit	Default	Cust	ID	Note
P2.7.1	Response to reference fault	0	5		4		700	0=No response 1=Warning 2=Warning+Old Freq. 3=Wrrng+PresetFreq 2.7.2 4=Fault,stop acc. to 2.4.7 5=Fault,stop by coasting
P2.7.2	Reference fault frequency	0,00	Par. 2.1.2	Hz	0,00		728	
P2.7.3	Response to external fault	0	3		2		701	0=No response 1=Warning 2=Fault,stop acc. to 2.4.7 3=Fault,stop by coasting
P2.7.4	Input phase supervision	0	3		2		730	
P2.7.5	Response to undervoltage fault	1	3		1		727	
P2.7.6	Output phase supervision	0	3		2		702	
P2.7.7	Earth fault protection	0	3		2		703	
P2.7.8	Thermal protection of the motor	0	3		2		704	
P2.7.9	Motor ambient temperature factor	-100,0	100,0	%	0,0		705	
P2.7.10	Motor cooling factor at zero speed	0,0	150,0	%	40,0		706	
P2.7.11	Motor thermal time constant	1	200	min	Varies		707	
P2.7.12	Motor duty cycle	0	100	%	100		708	
P2.7.13	Stall protection	0	3		2		709	0=No response 1=Warning 2=Fault,stop acc. to 2.4.7 3=Fault,stop by coasting
P2.7.14	Stall current	0,00	2 x I <sub>H</sub>	A	I <sub>H</sub>		710	
P2.7.15	Stall time limit	1,00	120,00	s	15,00		711	
P2.7.16	Stall frequency limit	1,0	Par. 2.1.2	Hz	25,0		712	
P2.7.17	Underload protection	0	3		0		713	0=No response 1=Warning 2=Fault,stop acc. to 2.4.7 3=Fault,stop by coasting
P2.7.18	Underload curve at nominal frequency	10	150	%	50		714	
P2.7.19	Underload curve at zero frequency	5,0	150,0	%	10,0		715	
P2.7.20	Underload protection time limit	2	600	s	20		716	
P2.7.21	Thermistor fault resp	0	3		0		732	0=No action 1=Warning 2=Fault 3=Fault, coast
P2.7.22	FB comm. fault	0	3		2		733	Response to fieldbus fault 0=No action 1=Warning 2=Fault 3=Fault, coast

P2.7.23	Slot comm. fault	0	3		2		734	Response to option card fault 0=No action 1=Warning 2=Fault 3=Fault, coast
P2.7.24	Value of actual value supervision	0,00	100,00	%	0,00		1518	
P2.7.25	Actual value over/under supervision value	0	2		0		1519	0=No action 1=Over 2=Under
P2.7.26	Actual value supervision response	0	3		0		1522	Response to Actual value supervision 0=No action 1=Warning 2=Fault 3=Fault, coast
P2.7.27	Actual value response time	0	300	s	1		1540	

Table 14. Protections, G2.7

### 2.6.11 Autorestart parameters (Control keypad: Menu M2 → G2.8)

Code	Parameter	Min	Max	Unit	Default	Csut	ID	Note
P2.8.1	Wait time	0,10	10,00	s	0,50		717	
P2.8.2	Trial time	0,00	60,00	s	30,00		718	
P2.8.3	Start function	0	2		0		719	0=Ramp 1=Flying start 2=According to par. 2.4.6
P2.8.4	Number of tries after undervoltage trip	0	10		2		720	
P2.8.5	Number of tries after overvoltage trip	0	10		2		721	
P2.8.6	Number of tries after overcurrent trip	0	3		2		722	
P2.8.7	Number of tries after reference trip	0	10		1		723	
P2.8.8	Number of tries after motor temperature fault trip	0	10		0		726	
P2.8.9	Number of tries after external fault trip	0	10		0		725	

Table 15. Autorestart parameters, G2.8

### 2.6.12 Keypad control (Control keypad: Menu M3)

The parameters for the selection of control place and direction on the keypad are listed below. See the Keypad control menu in the product's User's Manual.

Code	Parameter	Min	Max	Unit	Default	Cust	ID	Note
P3.1	Control place	1	3		1		125	1=I/O terminal 2=Keypad 3=Fieldbus
R3.2	Keypad reference	Par. 2.1.1	Par. 2.1.2	Hz				
R3.3	PID reference 1	0,00	100,00	%	40,00		167	
R3.4	PID reference 2	0,00	100,00	%	0,00		168	
R3.5	Stop Button	0	1		0		114	

Table 16. Keypad control parameters, M3

### 2.6.13 Expander boards (Control keypad: Menu M7)

The **M7** menu shows the expander and option boards attached to the control board and board-related information. For more information, see the product's User's Manual.

### 3. ADVANCED LEVEL CONTROL APPLICATION

#### 3.1 Brief description

With the *Advanced Level Control application* you can build a system where up to 3 drives control the pumping from a storage tank.

One frequency converter controls the pump that is the leading pump and handles the main regulation and the other ones are started if the liquid level in the tank is close to reaching the edge of the tank.

This system guarantees that the flow from the tank remains as steady as possible. In case of excessive amount of water in the tank for the leading pump to handle and the buffering capacity of the tank is not enough the auxiliary pumps will start before the tank flows over.

When you have the application package loaded in your Vacon drive you can select the **Advanced Level Control** application in system menu, **M6** with parameter *S6.2*.

#### 3.2 Functionality

The application is designed in order to achieve an even wear of the pumps connected to the motors/drives by regularly changing the leading drive. The application supports the maximum of 3 pumps to work in parallel. When the drive is activated via DIN1 the system decides, on the basis of the ID numbers of the drives, which drive is the leading drive. The leading one is regulating, either as PID or linearly between two points, while the auxiliary drives are either stand-by or, in case the start level is exceeded, started. The start order of the auxiliary drives is also based on the ID number.

Connections to/from and between the drives are easily made. The drive is connected directly to its own motor/pump. There is neither need for additional contactors nor any soft starting devices. An ordinary pair cable is used for the communications between drives.

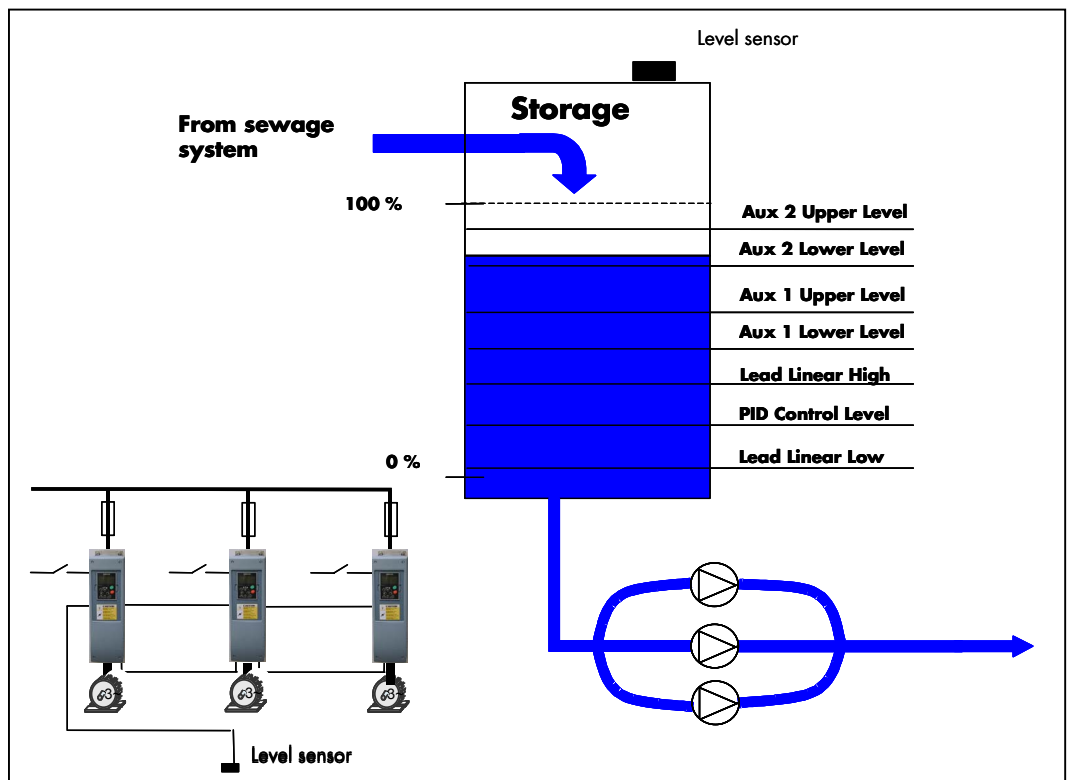

Figure 12. Principle of Advanced Level Control system

### 3.3 Level control and autochange

The leading drive runs either as a PID regulator or linearly between the set upper and lower limits. In case of great amount of incoming water, the leading drive will run at full speed and the tank will use its buffer capacity. If the level in the tank continues to rise the auxiliary pumps will start when the set level is reached, (parameter ID1566, *Aux1/2 Upper Level*).

The auxiliary pumps can either run at nominal production speed between the upper and lower limits or run linearly between the limits (default). It is also selectable if the auxiliary drives start from the lower or higher (default) limit when in *Linear* mode. If the auxiliary drives are running in *Nominal production* mode it will always start at a higher level.

The Vacon drives in the system will automatically change the leading drive to equalize the wear of the devices in the system.

The drive is counting time for the autochange event when it is running. The time to run before the autochange occurs can be set by the user.

When the drive reaches the set time, it will stop regulating and then slowly ramp down and stop. The other drives will notice that the drive is stopping for the autochange event and the next drive will become the leading one.

When all drives in the installation have performed their leading role the timers of all drives are reset. The "reset" command does not necessarily set the counters to zero, but the counter value is decreased by the autochange value set by the user. (Default value is 48h)

#### Examples:

Autochange time:	48h
Running hours:	64h
Running hours after reset:	$64-48=16h$

The counter value can increase over 48h (autochange value) if this drive has been running while the others have been in the leading role. This way the running times of the drives are equalized.

3.4 Control I/O

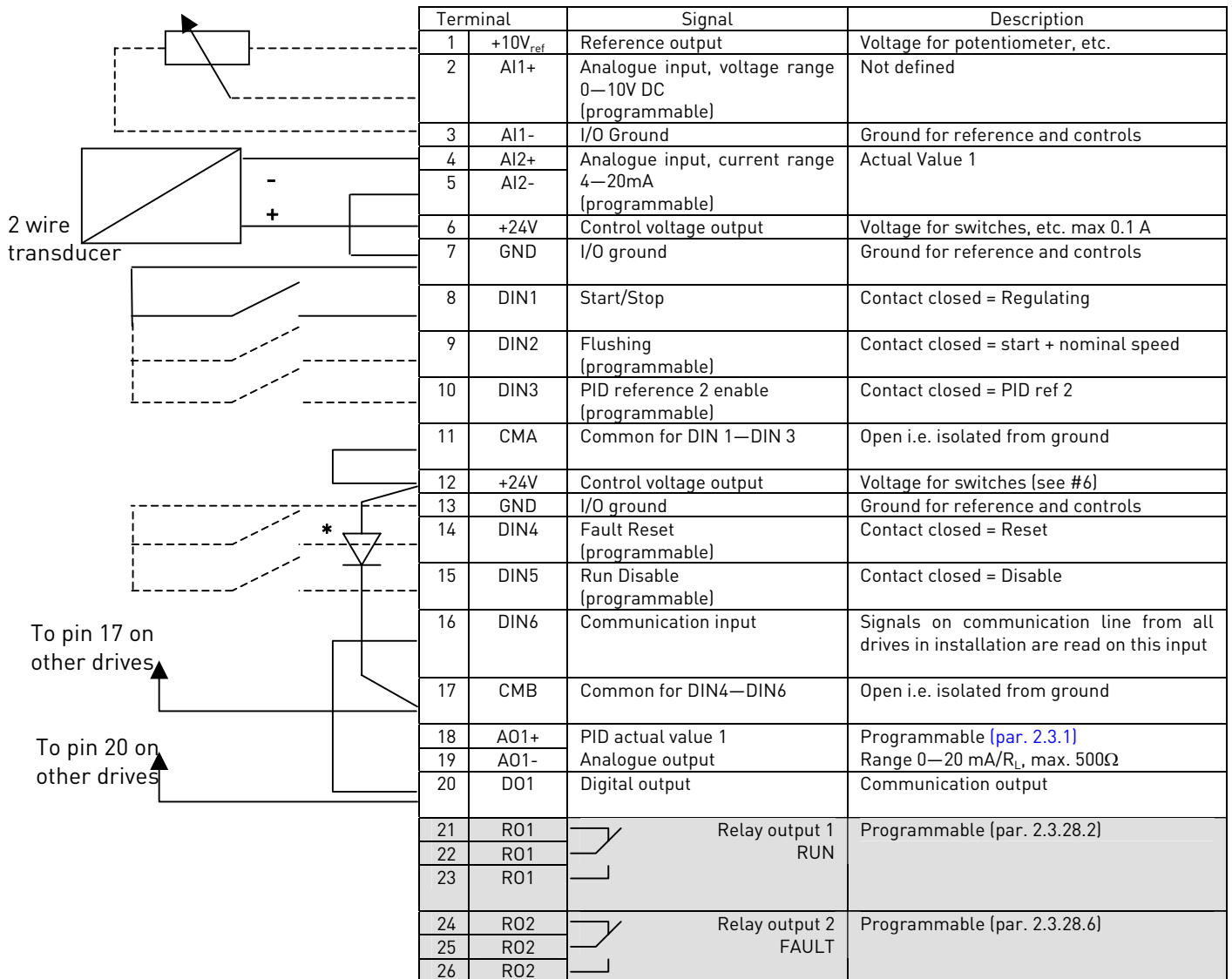

Figure 13. I/O configuration for the MultiMaster PFC application

\* = 1N4004

The diode is needed to prevent backward supply of 24V from other drives.

**NOTE!** All digital inputs are used with negative logic (0V is active). Jumper X3 has to be connected so that CMA and CMB are isolated from ground, i.e. OPEN. See Figure 14 below.

Digital inputs DIN3, DIN4, DIN5 and all the outputs are freely programmable. DIN6 and digital output (DO1) are reserved for the communication between drives.

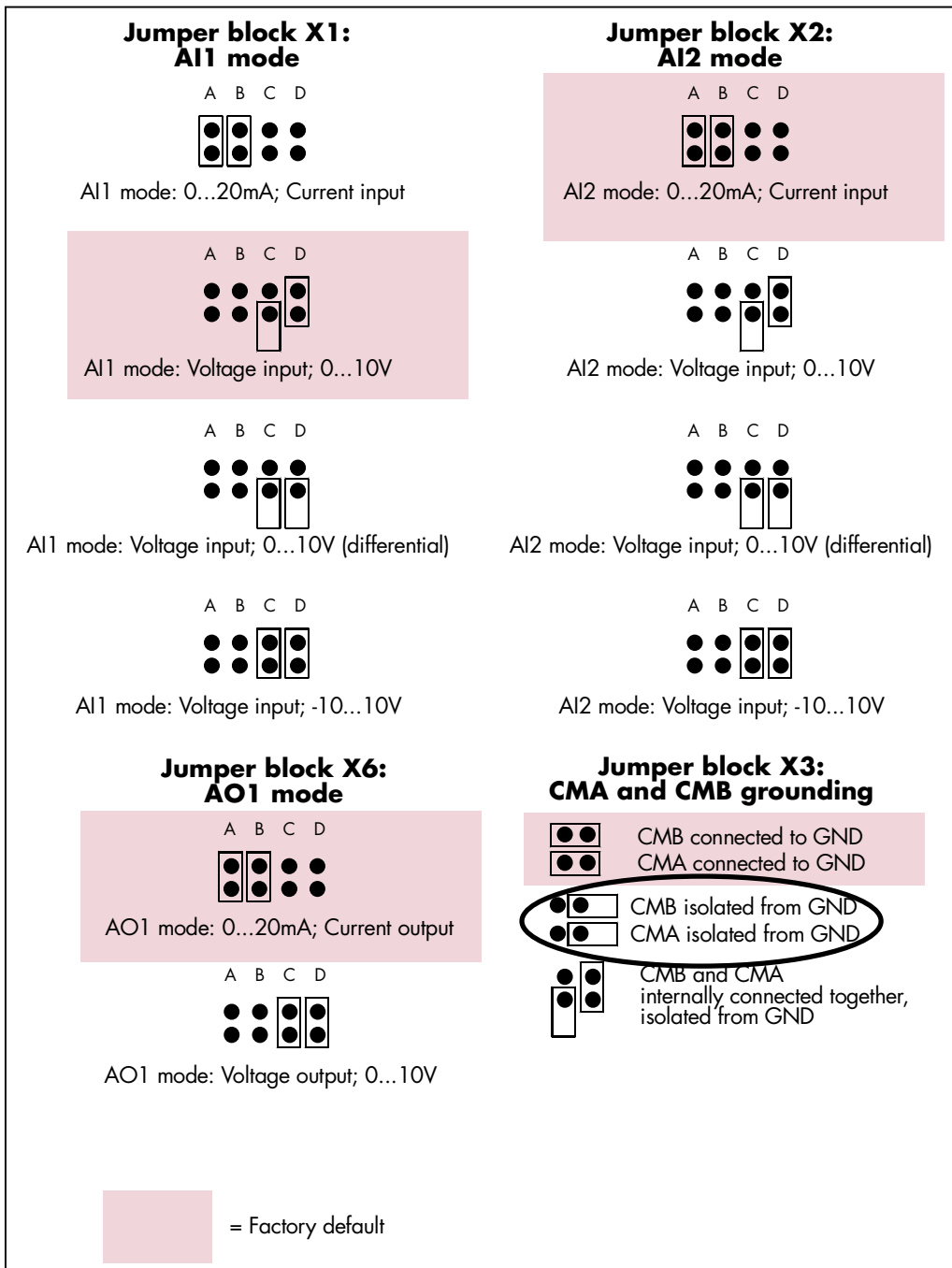



Figure 14. Jumper selection for OPT-A1

See also the product's User's manual for more details.

 <b>NOTE</b>	<p>If you change the AI/AO signal content also remember to change the corresponding board parameter in menu M7.</p>
--	---



### 3.5 Control logic in Advanced Level Control Application

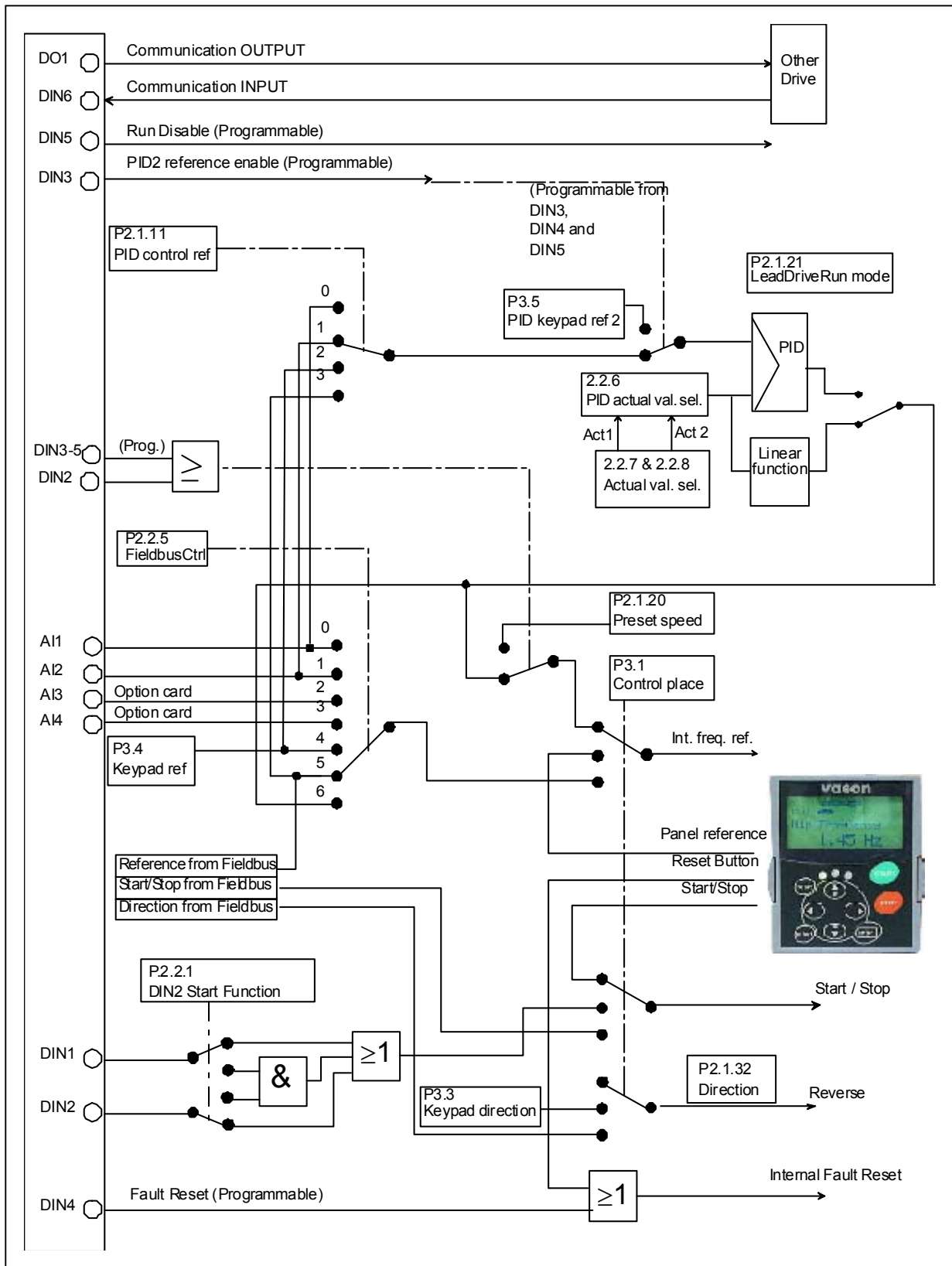



Figure 15. Control I/O logic in Advanced Level Control Application

### 3.6 Advanced Level Control Application – Parameter lists

On the next pages you will find the lists of parameters within the respective parameter groups. Each parameter includes a link to the respective parameter description. The parameter descriptions are given on pages 77 to 122.

#### Column explanations:

Code	=	Location indication on the keypad; Shows the operator the present param. number
Parameter	=	Name of parameter
Min	=	Minimum value of parameter
Max	=	Maximum value of parameter
Unit	=	Unit of parameter value; Given if available
Default	=	Value preset by factory
Cust	=	Customer's own setting
ID	=	ID number of the parameter (used with PC tools)
	=	Parameter value can only be changed after the FC has been stopped.
	=	In parameter row: Use TTF method to program these parameters

**3.6.1 Monitoring values (Control keypad: menu M1)**

The monitoring values are the actual values of parameters and signals as well as statuses and measurements. Monitoring values cannot be edited.

See the product's User's Manual for more information.

Code	Parameter	Unit	ID	Description
V1.1	Output frequency	Hz	1	Output frequency to motor
V1.2	Frequency reference	Hz	25	Frequency reference to motor control
V1.3	Motor speed	rpm	2	Motor speed in rpm
V1.4	Motor current	A	3	
V1.5	Motor torque	%	4	Calculated shaft torque
V1.6	Motor power	%	5	Motor shaft power
V1.7	Motor voltage	V	6	
V1.8	DC link voltage	V	7	
V1.9	Unit temperature	°C	8	Heat sink temperature
V1.10	Voltage input	V	13	AI1
V1.11	Current input	mA	14	AI2
V1.12	Analogue input	V/mA		AI3
V1.13	Analogue input	V/mA		AI4
V1.14	DIN1, DIN2, DIN3		15	Digital input statuses
V1.15	DIN4, DIN4, DIN6		16	Digital input statuses
V1.16	Analogue I <sub>out</sub>	mA	26	A01
V1.17	PID Reference	%	20	In percent of the maximum frequency
V1.18	PID Actual value	%	21	In percent of the max actual value
V1.19	PID Error value	%	22	In percent of the max error value
V1.20	PID Output	%	23	In percent of the max output value
V1.21	Period running hour	h	1503	Running hours of this period
V1.22	Period running min.	min	1504	Running minutes of this period
V1.23	Drive status		1511	0=Off 1=Communication line error 2=Stand-by 3=Regulating 4=Nom.prod. 5=Sleeping
V1.24	Status Word		1543	Give the Status Word to Vacon personnel in case of problems with running the application
V1.25	Actual value special display		1547	Actual value special display See par; ID1544 to ID1546
G1.26	Multimonitoring page			Displays three selectable monitoring values

Table 17. Monitoring values

### 3.6.2 Basic parameters (Control keypad: Menu M2 → G2.1)

Code	Parameter	Min	Max	Unit	Default	Cust	ID	Note
P2.1.1	Null producing limit	0,00	Par. 2.1.2	Hz	15,00		101	Min output freq / Sleep freq/ Change freq
P2.1.2	Max producing limit	Par. 2.1.1	320,00	Hz	50,00		102	<b>NOTE:</b> If $f_{max}$ > than the motor synchronous speed, check suitability for motor and drive system
P2.1.3	Acceleration time 1	0,1	3000,0	s	3,0		103	
P2.1.4	Deceleration time 1	0,1	3000,0	s	3,0		104	
P2.1.5	Current limit	$0,1 \times I_H$	$2 \times I_H$	A	$I_L$		107	
P2.1.6	Nominal voltage of the motor	180	690	V	NX2: 230V NX5: 400V NX6: 690V		110	
P2.1.7	Nominal frequency of the motor	8,00	320,00	Hz	50,00		111	Check the rating plate of the motor
P2.1.8	Nominal speed of the motor	24	20 000	rpm	1440		112	The default applies for a 4-pole motor and a nominal size frequency converter.
P2.1.9	Nominal current of the motor	$0,1 \times I_H$	$2 \times I_H$	A	$I_H$		113	Check the rating plate of the motor.
P2.1.10	Motor $\cos\phi$	0,30	1,00		0,85		120	Check the rating plate of the motor
P2.1.11	PID controller reference signal (Place A)	0	4		2		332	<b>0</b> =Anal.volt. input (#2–3) <b>1</b> =Anal.curr.input (#4–5) <b>2</b> =PID ref from Keypad control page, par. 3.4 <b>3</b> =PID ref from fieldbus (FBProcessDataIN1)
P2.1.12	PID controller gain	0,0	1000,0	%	100,0		118	
P2.1.13	PID controller I-time	0,00	320,00	s	1,00		119	
P2.1.14	PID controller D-time	0,00	10,00	s	0,00		132	
P2.1.15	Sleep delay	P2.1.16	3600	s	30		1017	
P2.1.16	Wake up level	0,00	100,00	%	30,00		1018	
P2.1.17	Wake up function	0	3		0		1019	<b>0</b> =Wake-up at fall below wake up level (2.1.16, % of Actual value max) <b>1</b> =Wake-up at exceeded wake up level (2.1.16, % of Actual value max) <b>2</b> =Wake-up at fall below wake up level (2.1.16, % of PID ref value max) <b>3</b> =Wake-up at exceeded wake up level (2.1.16, % of PID ref value max)
P2.1.18	Preset speed	0,00	Par. 2.1.2	Hz	50,00		124	
P2.1.19	Own ID number	0	3		0		1500	The specific ID number of the drive, in the specific installation
P2.1.20	Interval time	0	170	h	48		1501	The time after which the autochange will occur <b>0</b> =5 minutes (for commissioning) <b>170</b> =Autochange is by-passed
P2.1.21	Impeller cleaning time	0	10	s	2		1510	<b>0</b> =No impeller cleaning

P2.1.22	LeadDriveRunMode	0	1		0		1560	0=Leading drive regulates acc. to PID 1=Leading drive runs linearly
P2.1.23	LinearLeadLow	0,00	100,00	%	10,00		1561	
P2.1.24	LinearLeadHigh	0,00	100,00	%	50,00		1562	
P2.1.25	AuxDriveRunMode	0	1		1		1563	0=Aux drive run at nominal production speed 1=Aux drives run linearly between upper and lower levels
P2.1.26	AuxLinearStart	0	1		1		1564	0=At low level 1=At high level
P2.1.27	Aux1LowerLevel	0,00	100,00	%	75,00		1565	
P2.1.28	Aux1HigherLevel	0,00	100,00	%	80,00		1566	
P2.1.29	Aux2LowerLevel	0,00	100,00	%	85,00		1567	
P2.1.30	Aux2HigherLevel	0,00	100,00	%	90,00		1568	
P2.1.31	Reference step	0,00	100,00	%	0,00		1506	
P2.1.32	Constant production frequency	Par2.1.1	Par2.1.2	Hz	0,00		1513	
P2.1.33	Direction	0	1		0		1548	Reverse direction
P2.1.34	Special Display Min	0	30000		0		1544	
P2.1.35	Special Display Max	0	30000		100		1545	
P2.1.36	Special Display Dec	0	4		1		1546	
P2.1.37	Special display unit	0	28		4		1549	0=Not Used 1=% 2=°C 3=m 4=bar 5=mbar 6=Pa 7=kPa 8=PSI 9=m /s 10=l/s 11=l/min 12=l/h 13=m3/s 14=m3/min 15=m3/h 16=°F 17=ft 18=gal/s (GPS) 19=gal/min (GPM) 20=gal/h (GPH) 21=ft3/s (CFS) 22=ft3/min (CFM) 23=f3/h (CFH) 24=A 25=V 26=W 27=kW 28=Hp

Table 18. Basic parameters G2.1

### 3.6.3 Input signals (Control keypad: Menu M2 → G2.2)

Code	Parameter	Min	Max	Unit	Default	Cust	ID	Note
P2.2.1	DIN2 Start function	0	1		0		1508	0=DIN2 alone starts the drive at "pre-set speed" 1=Both DIN1 and DIN2 have to be activated before the drive will start and run at the speed set in <a href="#">P2.1.18</a>
<a href="#">P2.2.2</a>	DIN3 function	0	12		11		301	0=Not used 1=External fault cc 2=External fault oc 3=Run enable 4= CP: I/O terminal 5= CP: Keypad 6= CP: Fieldbus 7=Pre set speed 8=Fault reset 9=Acc./Dec.operation prohibit 10= DC braking command 11= Enable PID reference 2 12 = Run disable
<a href="#">P2.2.3</a>	DIN4 function	0	12		8		1509	See above
<a href="#">P2.2.4</a>	DIN5 function	0	12		12		330	See above
<a href="#">P2.2.5</a>	Fieldbus control reference selection	1	6		5		122	1=AI2 2=AI3 3=AI4 4=Panel reference 5=FB reference 6=PID controller
<a href="#">P2.2.6</a>	Actual value selection	0	7		0		333	0=Actual value 1 1=Actual 1 + Actual 2 2=Actual 1 - Actual 2 3=Actual 1 * Actual 2 4=Min[Actual 1, Actual 2] 5=Max[Actual 1, Actual 2] 6=Mean[Actual1, Actual2] 7=.Sqrt (Act1) + Sqrt (Act2)
<a href="#">P2.2.7</a>	Actual value 1 input	0	5		2		334	0=Not used 1=AI1 signal (c-board) 2=AI2 signal (c-board) 3=AI3 signal 4=AI4 signal 5=Fieldbus (FBProcessDataIN2)
<a href="#">P2.2.8</a>	Actual value 2 input	0	5		0		335	0=Not used 1=AI1 signal (c-board) 2=AI2 signal (c-board) 3=AI3 signal 4=AI4 signal 5=Fieldbus (FBProcessDataIN3)
P2.2.9	Actual value 1 minimum scale	-320,00	320,00	%	0,00		336	0=No minimum scaling
P2.2.10	Actual value 1 maximum scale	-320,00	320,00	%	100,00		337	100=No maximum scaling
P2.2.11	Actual value 2 minimum scale	-320,00	320,00	%	0,00		338	0=No minimum scaling
P2.2.12	Actual value 2 maximum scale	-320,00	320,00	%	100,00		339	100=No maximum scaling

P2.2.13	AI1 Signal select	0			A.1		1532	
P2.2.14	AI1 signal range	0	2		0		320	0=Signal range 0—10V 1=Signal range 2—10V 2=Custom range
P2.2.15	AI1 custom minimum setting	0,00	100,00	%	0,00		321	
P2.2.16	AI1 custom maximum setting	0,00	100,00	%	100,00		322	
P2.2.17	AI1 inversion	0	1		0		323	0=Not inverted 1=Inverted
P2.2.18	AI1 filter time	0,00	10,00	s	0,10		324	0=No filtering
P2.2.19	AI2 Signal select	0			A.2		1533	
P2.2.20	AI2 signal range	0	2		1		325	0=0—20 mA 1=4—20 mA 2=Customised
P2.2.21	AI2 custom minimum setting	0,00	100,00	%	0,00		326	
P2.2.22	AI2 custom maximum setting	0,00	100,00	%	100,00		327	
P2.2.23	AI2 inversion	0	1		0		328	0=Not inverted 1=Inverted
P2.2.24	AI2 filter time	0,00	10,00	s	0,10		329	0=No filtering
P2.2.25	PID minimum limit	-100,00	Par. 2.2.29	%	0,00		359	
P2.2.26	PID maximum limit	Par. 2.2.28	100,00	%	100,00		360	
P2.2.27	Error value inversion	0	1		0		340	0=No inversion 1=Inversion
P2.2.28	PID reference rising time	0,1	100,0	s	5,0		341	
P2.2.29	PID reference falling time	0,1	100,0	s	5,0		342	
P2.2.30	Easy changeover	0	1		0		366	0=Keep reference 1=Copy actual reference
P2.2.31	AI3 Signal select	0			0.1		141	
P2.2.32	AI3 Signal range	0	1		1		143	
P2.2.33	AI3 inversion	0	1		0		151	0=Not inverted 1=Inverted
P2.2.34	AI3 filter time	0,00	10,00	s	0,10		142	0=No filtering
P2.2.35	AI4 Signal select	0			0.1		152	
P2.2.36	AI4 Signal range	0	1		1		154	
P2.2.37	AI4 inversion	0	1		0		162	0=Not inverted 1=Inverted
P2.2.38	AI4 filter time	0,00	10,00	s	0,10		153	0=No filtering

Table 19. Input signals, G2.2

CP=control place  
cc=closing contact  
oc=opening contact

### 3.6.4 Output signals (Control keypad: Menu M2 → G2.3)

Code	Parameter	Min	Max	Unit	Default	Cust	ID	Note
P2.3.1	Analogue output function	0	13		10		307	0=Not used 1=Output freq. (0– $f_{max}$ ) 2=Freq. reference (0– $f_{max}$ ) 3=Motor speed (0–Motor nominal speed) 4=Output current (0– $I_{nMotor}$ ) 5=Motor torque (0– $T_{nMotor}$ ) 6=Motor power (0– $P_{nMotor}$ ) 7=Motor voltage (0– $U_{nMotor}$ ) 8=DC-link volt (0– $U_{nMotor}$ ) 9=PID controller ref. value 10=PID contr. act. value 1 11=PID contr. act. value 2 12=PID contr. error value 13=PID controller output
P2.3.2	Analogue output filter time	0,00	10,00	s	1,00		308	
P2.3.3	Analogue output inversion	0	1		0		309	0=Not inverted 1=Inverted
P2.3.4	Analogue output minimum	0	1		0		310	0=0 mA 1=4 mA
P2.3.5	Analogue output scale	10	1000	%	100		311	
P2.3.6	Output frequency limit 1 supervision	0	2		0		315	0=No limit 1=Low limit supervision 2=High limit supervision
P2.3.7	Output frequency limit 1; Supervised value	0,00	Par. 2.1.2	Hz	0,00		316	
P2.3.8	Output frequency limit 2 supervision	0	2		0		346	0=No limit 1=Low limit supervision 2=High limit supervision
P2.3.9	Output frequency limit 2; Supervised value	0,00	Par. 2.1.2	Hz	0,00		347	
P2.3.10	Torque limit supervision	0	2		0		348	0=Not used 1=Low limit supervision 2=High limit supervision
P2.3.11	Torque limit supervision value	0,0	300,0	%	100,0		349	
P2.3.12	FC temperature supervision	0	2		0		354	0=Not used 1=Low limit 2=High limit
P2.3.13	FC temperature supervised value	-10	100	°C	40		355	
P2.3.14	Actual value supervision to relay	0	100,00	%	0,00		1541	
P2.3.15	Actual value over / under sup value to relay	0	2		0		1542	0=Not used 1=Over supervised value 2=Under supervised value
P2.3.16	lout2 signal	0			0.1		471	
P2.3.17	lout2 content	0	13		7		472	
P2.3.18	lout2 filter time	0,00	10,00	s	1,00		473	
P2.3.19	lout2 invert	0	1		0		474	
P2.3.20	lout2 minimum	0	1		0		475	
P2.3.21	lout2 scale	10	1000	%	0		476	
P2.3.22	lout3 signal	0			0.1		1534	
P2.3.23	lout3 content	0	13		0		1535	
P2.3.24	lout3 filter time	0,00	10,00	s	0,00		1536	



P2.3.25	<a href="#">lout3 invert</a>	0	1		0		1527	
P2.3.26	<a href="#">lout3 minimum</a>	0	1		0		1538	
P2.3.27	<a href="#">lout3 scale</a>	10	1000	%	0		1539	

Table 20. Output signals, G2.3

**3.6.5 Delayed Output signals R01 and R02 (Control keypad: Menu M2 → G2.3.28)**

Code	Parameter	Min	Max	Unit	Default	Cust	ID	Note
P2.3.28.1	<a href="#">R01 Signal</a>	0			B.1		1524	
P2.3.28.2	<a href="#">R01 Content</a>		16		2		1525	0= Not used 1= Ready 2= Run 3= Fault 4= Fault inverted 5= Warning 6= External fault or warning 7=Reference fault or warning 8= Vacon overheat warning 9= Preset speed 10=Output freq. limit sup. 1 11=Output freq. limit sup. 2 12=Thermistor fault/warning 13=Torque limit supervision 14=Motor thermal fault warn 15=Motor reg. activated 16=Act. value limit superv.
P2.3.28.3	<a href="#">R01 On delay</a>	0,00	320,00	s	0,00		1526	
P2.3.28.4	<a href="#">R01 Off delay</a>	0,00	320,00	s	0,00		1527	
P2.3.28.5	<a href="#">R02 Signal</a>	0			B.2		1528	
P2.3.28.6	<a href="#">R02 Content</a>	0	16		3		1529	See P2.3.28.2
P2.3.28.7	<a href="#">R02 On delay</a>	0	320,00	s	0,00		1530	
P2.3.28.8	<a href="#">R02 Off delay</a>	0	320,00	s	0,00		1531	

Table 21. Delayed output signals, G2.3.28

### 3.6.6 Relay outputs (Control keypad: Menu M2 → G2.3.29)

Code	Parameter	Min	Max	Default	Cust	ID	Note
P2.3.29.1	Ready	0		A.1		432	
P2.3.29.2	Run	0		B.1		433	
P2.3.29.3	Fault	0		B.2		434	
P2.3.29.4	Fault, inverted	0		0.2		435	
P2.3.29.5	Warning	0		0.1		436	
P2.3.29.6	External fault/warning	0		0.1		437	
P2.3.29.7	AI ref fault/warning	0		0.1		438	
P2.3.29.8	Overtemp warning	0		0.1		439	
P2.3.29.9	Preset speed	0		0.1		443	
P2.3.29.10	FreqOut superv.limit1	0		0.1		447	
P2.3.29.11	FreqOut superv.limit2	0		0.1		448	
P2.3.29.12	Temp lim superv	0		0.1		450	
P2.3.29.13	Torq limit superv	0		0.1		451	
P2.3.29.14	Motor term fault/warn	0		0.1		452	
P2.3.29.15	Motor reg active	0		0.1		454	
P2.3.29.16	Actual value superv	0		0.1		1523	

Table 22. Relay output signals, G2.3.29

**3.6.7 Drive control parameters (Control keypad: Menu M2 → G2.4)**

Code	Parameter	Min	Max	Unit	Default	Cust	ID	Note
P2.4.1	Ramp 1 shape	0,1	10,0	s	0,0		500	0=Linear >0=S-curve ramp time
P2.4.2	Ramp 2 shape	0,1	10,0	s	0,0		501	0=Linear >0=S-curve ramp time
P2.4.3	Acceleration time 2	0,1	3000,0	s	5,0		502	
P2.4.4	Deceleration time 2	0,1	3000,0	s	5,0		503	
P2.4.5	Brake chopper	0	3		0		504	0=Disabled 1=Used and tested in Run state 2=External brake chopper 3=Used and tested in Ready state
P2.4.6	Start function	0	1		0		505	0=Ramp 1=Flying start
P2.4.7	Stop function	0	3		1		506	0=Coasting 1=Ramp 2=Ramp+Run enable coast 3=Coast+Run enable ramp
P2.4.8	DC braking current	0,00	$I_L$	A	$0,7 \times I_H$		507	
P2.4.9	DC braking time at stop	0,00	60,00	s	0,00		508	0=DC brake is off at stop
P2.4.10	Frequency to start DC braking during ramp stop	0,10	10,00	Hz	0,00		515	
P2.4.11	DC braking time at start	0,00	60,00	s	0,00		516	0=DC brake is off at start
P2.4.12	Flux brake	0	1		0		520	0=Off 1=On
P2.4.13	Flux braking current	0,00	$I_L$	A	$I_H$		519	

Table 23. Drive control parameters, G2.4

**3.6.8 Prohibit frequency parameters (Control keypad: Menu M2 → G2.5)**

Code	Parameter	Min	Max	Unit	Default	Cust	ID	Note
P2.5.1	Prohibit frequency range 1 low limit	0,0	Par. 2.5.2	Hz	0,0		509	0=Not used
P2.5.2	Prohibit frequency range 1 high limit	0,0	Par. 2.1.2	Hz	0,0		510	0=Not used
P2.5.3	Prohibit frequency range 2 low limit	0,0	Par. 2.5.4	Hz	0,0		511	0=Not used
P2.5.4	Prohibit frequency range 2 high limit	0,0	Par. 2.1.2	Hz	0,0		512	0=Not used
P2.5.5	Prohibit frequency range 3 low limit	0,0	Par. 2.5.6	Hz	0,0		513	0=Not used
P2.5.6	Prohibit frequency range 3 high limit	0,0	Par. 2.1.2	Hz	0,0		514	0=Not used
P2.5.7	Prohibit frequencies acc./dec. ramp scaling	0,1	10,0	Times	1,0		518	

Table 24. Prohibit frequency parameters, G2.5

### 3.6.9 Motor control parameters (Control keypad: Menu M2 → G2.6)

Code	Parameter	Min	Max	Unit	Default	Cust	ID	Note
P2.6.1	Motor control mode	0	1		0		600	0= Frequency control 1= Speed control
P2.6.2	U/f optimisation	0	1		0		109	0= Not used 1= Automatic torque boost
P2.6.3	U/f ratio selection	0	3		0		108	0= Linear 1= Squared 2= Programmable 3= Linear with flux optim.
P2.6.4	Field weakening point	30,00	320,00	Hz	50,00		602	
P2.6.5	Voltage at field weakening point	10,00	200,00	%	100,00		603	$n\% \times U_{nmot}$
P2.6.6	U/f curve midpoint frequency	0,00	par. P2.6.4	Hz	50,00		604	
P2.6.7	U/f curve midpoint voltage	0,00	100,00	%	100,00		605	$n\% \times U_{nmot}$ Parameter max. value = par. 2.6.5
P2.6.8	Output voltage at zero frequency	0,00	40,00	%	Varies		606	$n\% \times U_{nmot}$
P2.6.9	Switching frequency	1,0	16,0	kHz	Varies		601	Depends on kW
P2.6.10	Overvoltage controller	0	1		1		607	0=Not used 1=Used (no ramping) 2=Used (ramping)
P2.6.11	Undervoltage controller	0	1		1		608	0=Not used 1=Used (no ramping) 2=Used (ramping)

Table 25. Motor control parameters, G2.6

**3.6.10 Protections (Control keypad: Menu M2 → G2.7)**

Code	Parameter	Min	Max	Unit	Default	Cust	ID	Note
P2.7.1	Response to reference fault	0	5		4		700	0=No response 1=Warning 2=Warning+Old Freq. 3=Wrng+PresetFreq 2.7.2 4=Fault,stop acc. to 2.4.7 5=Fault,stop by coasting
P2.7.2	Reference fault frequency	0,00	Par. 2.1.2	Hz	0,00		728	
P2.7.3	Response to external fault	0	3		2		701	0=No response 1=Warning 2=Fault,stop acc. to 2.4.7 3=Fault,stop by coasting
P2.7.4	Input phase supervision	0	3		2		730	
P2.7.5	Response to undervoltage fault	1	3		1		727	
P2.7.6	Output phase supervision	0	3		2		702	
P2.7.7	Earth fault protection	0	3		2		703	
P2.7.8	Thermal protection of the motor	0	3		2		704	
P2.7.9	Motor ambient temperature factor	-100,0	100,0	%	0,0		705	
P2.7.10	Motor cooling factor at zero speed	0,0	150,0	%	40,0		706	
P2.7.11	Motor thermal time constant	1	200	min	Varies		707	
P2.7.12	Motor duty cycle	0	100	%	100		708	
P2.7.13	Stall protection	0	3		2		709	0=No response 1=Warning 2=Fault,stop acc. to 2.4.7 3=Fault,stop by coasting
P2.7.14	Stall current	0,00	2 x I <sub>H</sub>	A	I <sub>H</sub>		710	
P2.7.15	Stall time limit	1,00	120,00	s	15,00		711	
P2.7.16	Stall frequency limit	1,0	Par. 2.1.2	Hz	25,0		712	
P2.7.17	Underload protection	0	3		0		713	0=No response 1=Warning 2=Fault,stop acc. to 2.4.7 3=Fault,stop by coasting
P2.7.18	Underload curve at nominal frequency	10	150	%	50		714	
P2.7.19	Underload curve at zero frequency	5,0	150,0	%	10,0		715	
P2.7.20	Underload protection time limit	2	600	s	20		716	
P2.7.21	Thermistor fault resp	0	3		0		732	0=No action 1=Warning 2=Fault 3=Fault, coast
P2.7.22	FB comm. fault	0	3		2		733	Response to fieldbus fault 0=No action 1=Warning 2=Fault 3=Fault, coast

P2.7.23	Slot comm. fault	0	3		2		734	Response to option card fault 0=No action 1=Warning 2=Fault 3=Fault, coast
P2.7.24	Value of actual value supervision	0,00	100,00	%	0,00		1518	
P2.7.25	Actual value over/under supervision value	0	2		0		1519	0=No action 1=Over 2=Under
P2.7.26	Actual value supervision response	0	3		0		1522	Response to Actual value supervision 0=No action 1=Warning 2=Fault 3=Fault, coast
P2.7.27	Actual value response time	0	300	s	1		1540	

Table 26. Protections, G2.7

### 3.6.11 Autorestart parameters (Control keypad: Menu M2 → G2.8)

Code	Parameter	Min	Max	Unit	Default	Csut	ID	Note
P2.8.1	Wait time	0,10	10,00	s	0,50		717	
P2.8.2	Trial time	0,00	60,00	s	30,00		718	
P2.8.3	Start function	0	2		0		719	0=Ramp 1=Flying start 2=According to par. 2.4.6
P2.8.4	Number of tries after undervoltage trip	0	10		2		720	
P2.8.5	Number of tries after overvoltage trip	0	10		2		721	
P2.8.6	Number of tries after overcurrent trip	0	3		2		722	
P2.8.7	Number of tries after reference trip	0	10		1		723	
P2.8.8	Number of tries after motor temperature fault trip	0	10		0		726	
P2.8.9	Number of tries after external fault trip	0	10		0		725	

Table 27. Autorestart parameters, G2.8

**3.6.12 Keypad control (Control keypad: Menu M3)**

The parameters for the selection of control place and direction on the keypad are listed below. See the Keypad control menu in the product's User's Manual.

Code	Parameter	Min	Max	Unit	Default	Cust	ID	Note
P3.1	Control place	1	3		1		125	1=I/O terminal 2=Keypad 3=Fieldbus
R3.2	Keypad reference	Par. 2.1.1	Par. 2.1.2	Hz				
P3.3	Direction (on keypad)	0	1		0		123	
R3.4	PID reference 1	0,00	100,00	%	40,00		167	
R3.5	PID reference 2	0,00	100,00	%	0,00		168	
R3.6	Stop Button	0	1		0		114	

Table 28. Keypad control parameters, M3

**3.6.13 Expander boards (Control keypad: Menu M7)**

The M7 menu shows the expander and option boards attached to the control board and board-related information. For more information, see the product's User's Manual.

## 4. MULTIFOLLOWER PFC APPLICATION

### 4.1 Brief description

With the MultiFollower PFC application you can build a system where up to 3 drives handle the regulation. The internal PID regulator controls the drives that are working in a chained control where one of them is always the regulating drive. This way they can together control a system with several devices in parallel.

When you have the application package loaded in your Vacon drive you can select the MultiFollower PFC application in system menu, **M6** with parameter *S6.2*.

### 4.2 Functionality

The application is designed to achieve an even wear of the pumps connected to the motors/ drives by regularly changing the regulating order to of the drives. The application supports the maximum of 3 pumps, fans or compressors to work in parallel.

One drive is leading and regulating (PID) while the others are either stand-by or, if working as auxiliary drives, following the same speed that the leading one is running at.

Connections to/ from and between the drives are made easily. The drive is connected directly to its own motor/ pump. There is neither need for additional contactors nor any soft starting devices. An ordinary shielded twisted pair cable is used for the communications between drives, and for the shared frequency reference transmission.

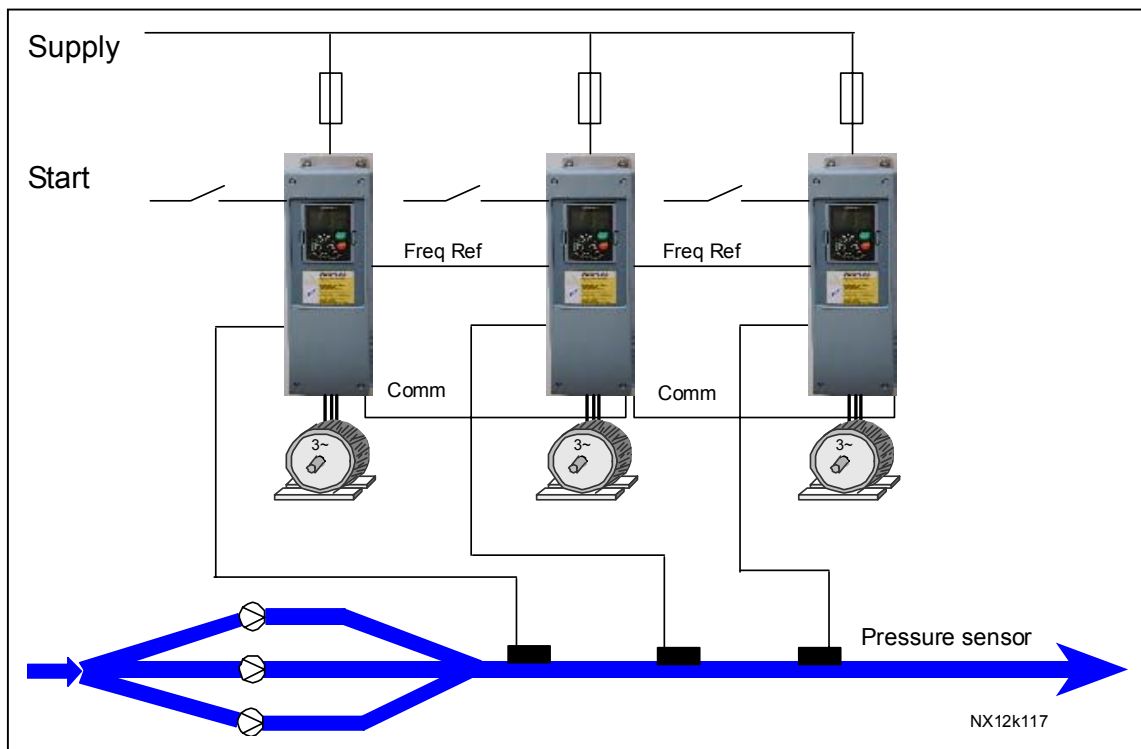

Figure 16. Operating principle of MultiFollower PFC system



### 4.3 Chained regulation and autochange

When the regulating drive notices a demand for more capacity, but cannot produce this by itself, it will send a request for NEXT START to the communication line. When the next drive starts to regulate it will send the frequency reference to the analogue output. The drive(s) that is (are) working as an auxiliary drive will read this value from its analogue input 1, and it will start to run at the same speed as the regulating drive. In other words, the auxiliary pump is following the speed reference of the leading drive /pump.

When the regulating drive notices that there is too much capacity (running at the minimum producing frequency + 1,5Hz) AND there are auxiliary units connected to the system, it will put itself to Stand-by mode and the auxiliary drive will become the leading drive and start regulating. If there are several drives working as auxiliary drives, the one with the highest priority will start to regulate. If there are NO auxiliary drives available when the drive notices the overcapacity, the drive will go into Sleeping mode.

The Vacon drives in the system will automatically change the leading drive to equalize the wear of the devices in the system.

The drive is counting time for the autochange event when it is running. The time to run before the autochange event shall occur can be set by the user.

When the drive reaches the set time, it will stop regulating and then slowly ramp down and stop. The other drives will notice that the drive is stopping for the autochange event and the next drive will take up the control.

When all drives in the installation have performed their leading role the timers of all drives are reset. The "reset" command does not necessarily set the counters to zero, but the counter value is decreased by the autochange value set by the user. (Default value is 48h)

Examples:

Autochange time:	48h
Running hours:	64h
Running hours after reset:	$64-48=16h$

The counter value can increase over 48h (autochange value) if this drive has been running while the others have been in the leading role. This way the running times of the drives are equalized.

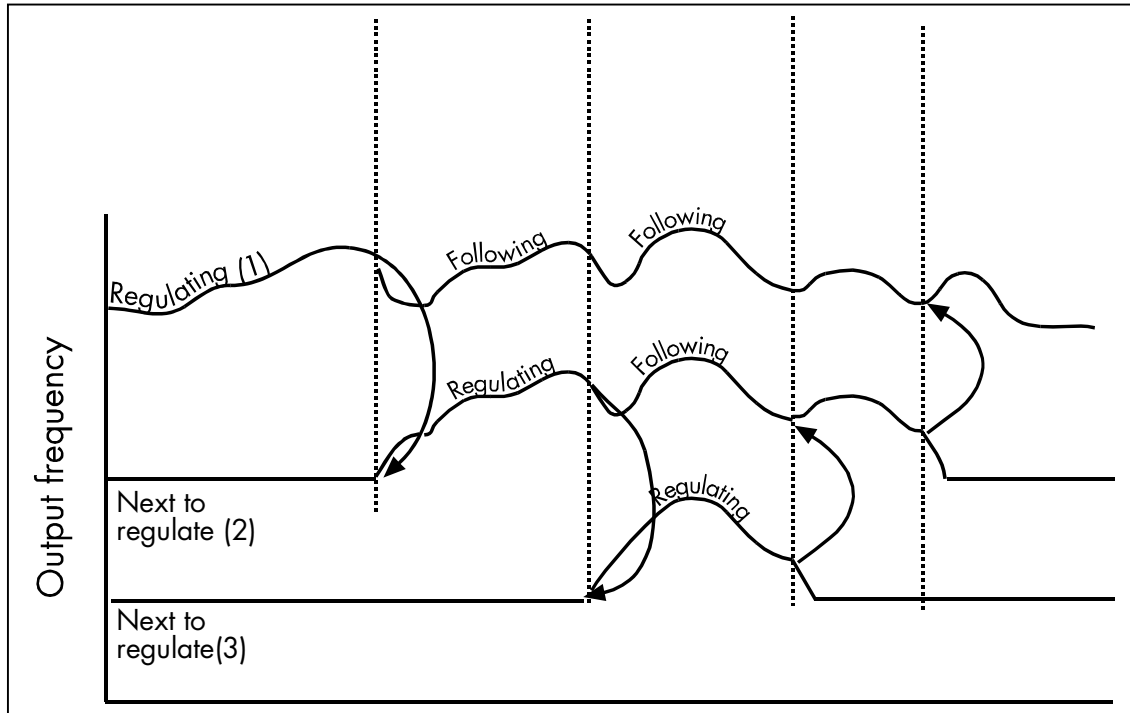

Figure 17. Chained regulation of MultiFollower PFC

### 4.4 Sharing of frequency reference

The auxiliary drives will follow the frequency reference that the leading drive is using. The leading drive sends out the frequency reference to the analogue output. The activated auxiliary drives will see this on analogue input 1 and follow the leading drive using the same frequency.

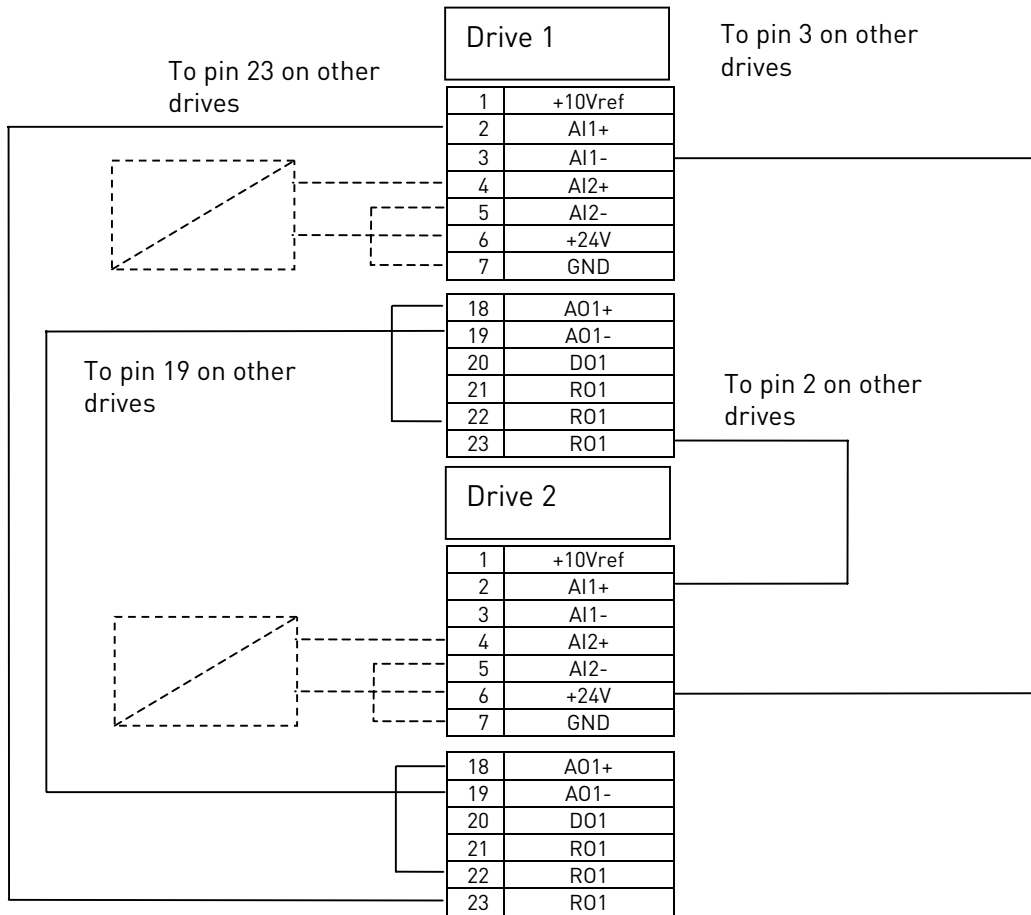

Figure 18. Connections for shared frequency reference in a 2 pump system

4.5 Control I/O for MultiFollower PFC

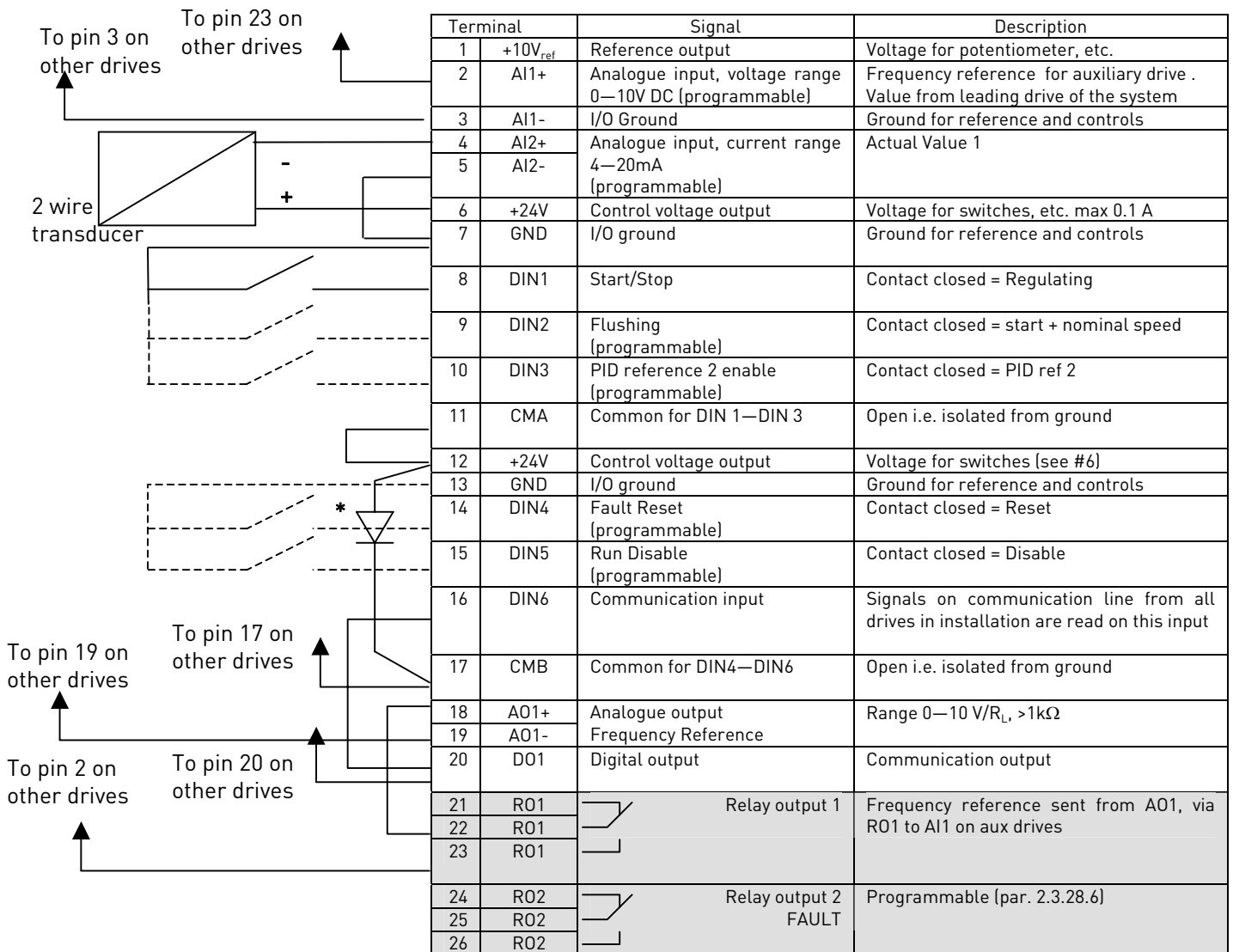

Figure 19. I/O configuration for the MultiFollower PFC Application

\* = 1N4004

The diode is needed to prevent backward supply of 24V from other drives.

**NOTE!** All digital inputs are used with negative logic (0V is active). Jumper X3 has to be connected so that CMA and CMB are isolated from ground, i.e. OPEN.

A01 must also be configured as Voltage output. See Figure 10 below.

Digital inputs DIN3, DIN4, DIN5 and all the outputs are freely programmable. DIN6 and the digital output (DO1) are reserved for the communication between drives.

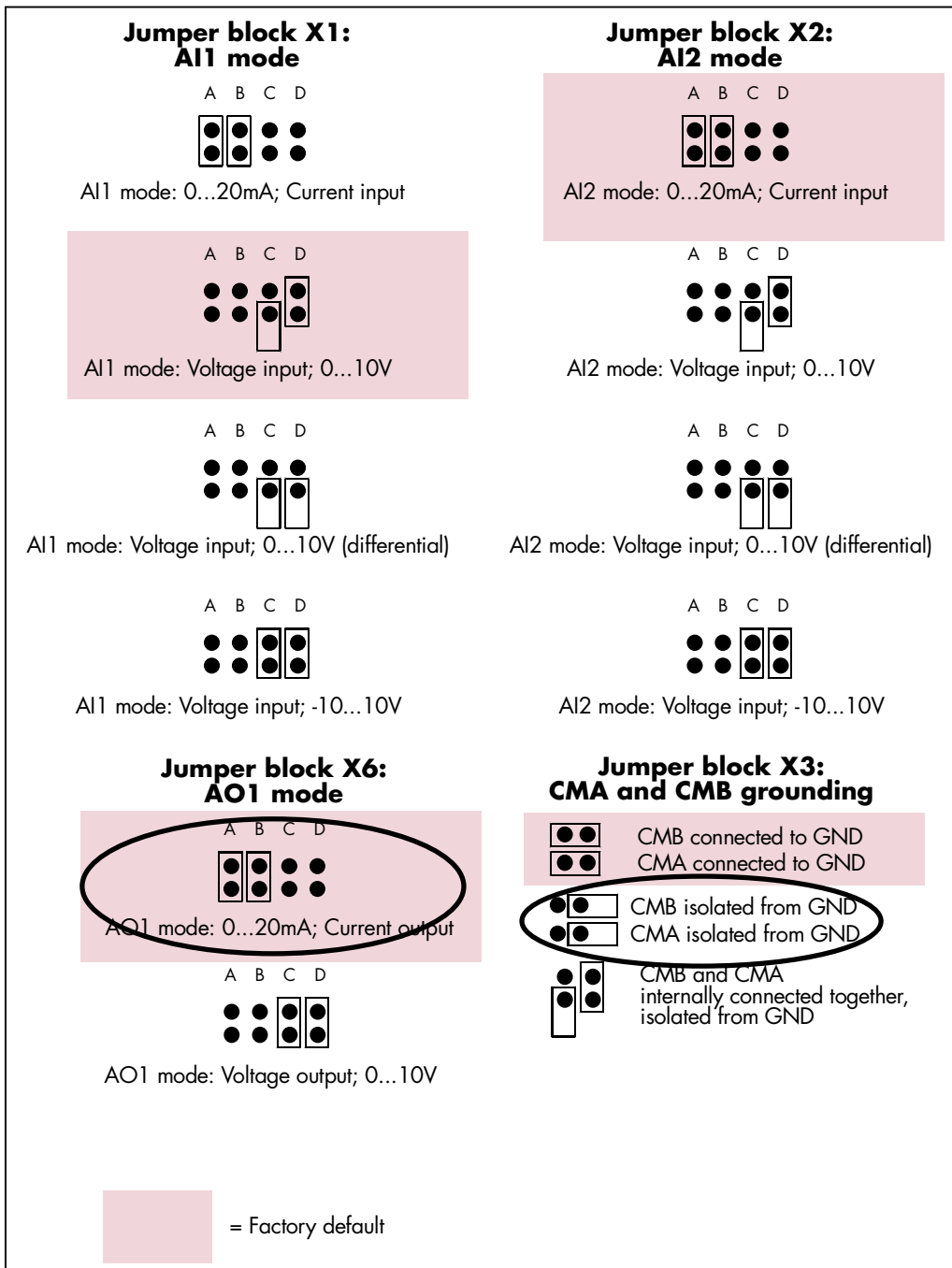



Figure 20. Jumper selection for OPT-A1

See also the product's User's manual for more details.

 <b>NOTE</b>	<p>If you change the AI/AO signal content also remember to change the corresponding board parameter in menu M7.</p>
--	---

4.6 Control signal logic in MultiFollower PFC Application

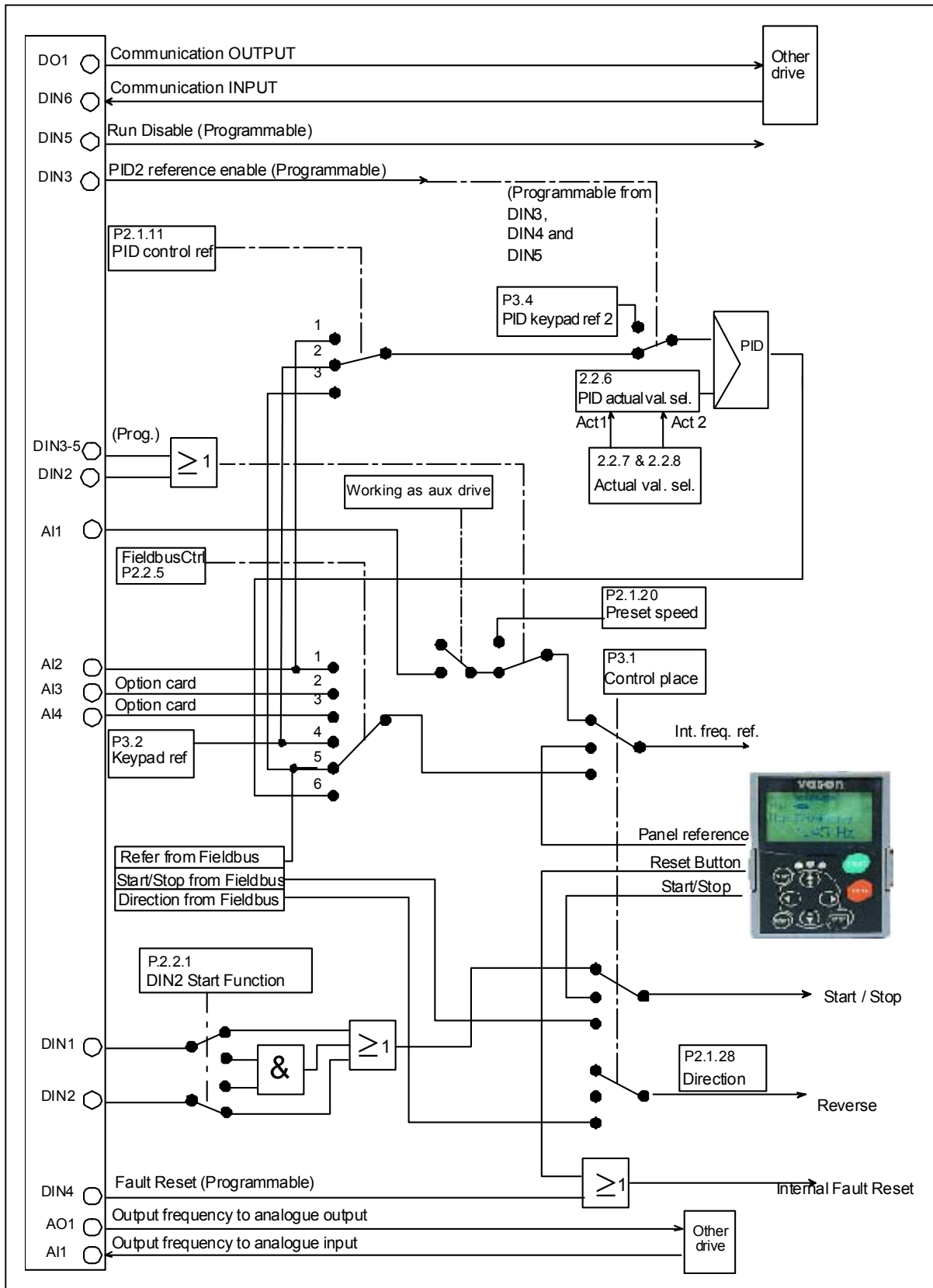



Figure 21. Control I/O logic, MultiFollower PFC Application

## 4.7 MultiFollower PFC Application – Parameter lists

On the next pages you will find the lists of parameters within the respective parameter groups. Each parameter includes a link to the respective parameter description. The parameter descriptions are given on pages 77 to 122.

### Column explanations:

Code	=	Location indication on the keypad; Shows the operator the present param. number
Parameter	=	Name of parameter
Min	=	Minimum value of parameter
Max	=	Maximum value of parameter
Unit	=	Unit of parameter value; Given if available
Default	=	Value preset by factory
Cust	=	Customer's own setting
ID	=	ID number of the parameter (used with PC tools)
	=	Parameter value can only be changed after the FC has been stopped.
	=	In parameter row: Use TTF method to program these parameters

#### 4.7.1 Monitoring values (Control keypad: menu M1)

The monitoring values are the actual values of parameters and signals as well as statuses and measurements. Monitoring values cannot be edited.

See the product's User's Manual for more information.

Code	Parameter	Unit	ID	Description
V1.1	Output frequency	Hz	1	Output frequency to motor
V1.2	Frequency reference	Hz	25	Frequency reference to motor control
V1.3	Motor speed	rpm	2	Motor speed in rpm
V1.4	Motor current	A	3	
V1.5	Motor torque	%	4	Calculated shaft torque
V1.6	Motor power	%	5	Motor shaft power
V1.7	Motor voltage	V	6	
V1.8	DC link voltage	V	7	
V1.9	Unit temperature	°C	8	Heat sink temperature
V1.10	Voltage input	V	13	AI1
V1.11	Current input	mA	14	AI2
V1.12	Analogue input			AI3
V1.13	Analogue input			AI4
V1.14	DIN1, DIN2, DIN3		15	Digital input statuses
V1.15	DIN4, DIN4, DIN6		16	Digital input statuses
V1.16	Analogue I <sub>out</sub>	mA	26	AO1
V1.17	PID Reference	%	20	In percent of the maximum frequency
V1.18	PID Actual value	%	21	In percent of the max actual value
V1.19	PID Error value	%	22	In percent of the max error value
V1.20	PID Output	%	23	In percent of the max output value
V1.21	Period running hour	h	1503	Running hours of this period
V1.22	Period running min.	min	1504	Running minutes of this period
V1.23	Drive status		1511	0=Off 1=Communication line error 2=Stand-by 3=Regulating 4=Following 5=Sleeping
V1.24	Status Word		1543	Give the Status Word to Vacon personnel in case of problems with running the application
V1.25	Actual value special display		1547	Actual value special display See par; ID1544 to ID1546
G1.26	Multimonitoring items			Displays three selectable monitoring values

Table 29. Monitoring values



## 4.7.2 Basic parameters (Control keypad: Menu M2 → G2.1)

Code	Parameter	Min	Max	Unit	Default	Cust	ID	Note
P2.1.1	Null producing limit	0,00	Par. 2.1.2	Hz	15,00		101	Min output freq / Sleep freq/ Change freq
P2.1.2	Max producing limit	Par. 2.1.1	320,00	Hz	50,00		102	<b>NOTE:</b> If $f_{max}$ > than the motor synchronous speed, check suitability for motor and drive system
P2.1.3	Acceleration time 1	0,1	3000,0	s	3,0		103	
P2.1.4	Deceleration time 1	0,1	3000,0	s	3,0		104	
P2.1.5	Current limit	$0,1 \times I_H$	$2 \times I_H$	A	$I_L$		107	
P2.1.6	Nominal voltage of the motor	180	690	V	NX2: 230V NX5: 400V NX6: 690V		110	
P2.1.7	Nominal frequency of the motor	8,00	320,00	Hz	50,00		111	Check the rating plate of the motor
P2.1.8	Nominal speed of the motor	24	20 000	rpm	1440		112	The default applies for a 4-pole motor and a nominal size frequency converter.
P2.1.9	Nominal current of the motor	$0,1 \times I_H$	$2 \times I_H$	A	$I_H$		113	Check the rating plate of the motor.
P2.1.10	Motor $\cos\phi$	0,30	1,00		0,85		120	Check the rating plate of the motor
P2.1.11	PID controller reference signal (Place A)	1	3		2		332	1=Anal.curr.input (#4–5) 2=PID ref from Keypad control page, par. 3.4 3=PID ref from fieldbus (FBProcessDataIN1)
P2.1.12	PID controller gain	0,0	1000,0	%	100,0		118	
P2.1.13	PID controller I-time	0,00	320,00	s	1,00		119	
P2.1.14	PID controller D-time	0,00	10,00	s	0,00		132	
P2.1.15	Next start delay	0	3600	s	5		1505	**]
P2.1.16	Own stop delay	0	3600	s	2		1512	**]
P2.1.17	Sleep delay	P2.1.16	3600	s	30		1017	
P2.1.18	Wake up level	0,00	100,00	%	30,00		1018	
P2.1.19	Wake up function	0	3		0		1019	0=Wake-up at fall below wake up level (2.1.18, % of Actual value max) 1=Wake-up at exceeded wake up level (2.1.18, % of Actual value max) 2=Wake-up at fall below wake up level (2.1.18, % of PID ref value max) 3=Wake-up at exceeded wake up level (2.1.18, % of PID ref value max)
P2.1.20	Preset speed	0,00	Par. 2.1.2	Hz	50,00		124	
P2.1.21	Own ID number	0	3		0		1500	The specific ID number of the drive, in the specific installation
P2.1.22	Interval time	0	170	h	48		1501	The time after which the autochange will occur 0 = 5minutes (for commissioning) 170 = Autochange is bypassed
P2.1.23	Reference step	0,00	100,00	%	0,00		1506	
P2.1.24	Direction	0	1		0		1548	Reverse direction

P2.1.25	Special Display Min	0	30000		0		1544	
P2.1.26	Special Display Max	0	30000		100		1545	
P2.1.27	Special Display Dec	0	4		1		1546	
P2.1.28	Special Display Unit	0	28		4		1549	0=Not Used 1=% 2=°C 3=m 4=bar 5=mbar 6=Pa 7=kPa 8=PSI 9=m /s 10=l/s 11=l/min 12=l/h 13=m3/s 14=m3/min 15=m3/h 16=°F 17=ft 18=gal/s (GPS) 19=gal/min (GPM) 20=gal/h (GPH) 21=ft3/s (CFS) 22=ft3/min (CFM) 23=f3/h (CFH) 24=A 25=V 26=W 27=kW 28=Hp

Table 30. Basic parameters G2.1

\*\*) If BOTH 2.1.15 and 2.1.16 are "0", only one drive is handling all the pumping capacity. I.e. auxiliary drives are not requested. The autochange function works, however.

### 4.7.3 Input signals (Control keypad: Menu M2 → G2.2)

Code	Parameter	Min	Max	Unit	Default	Cust	ID	Note
P2.2.1	DIN2 Start function	0	1		0		1508	0=DIN2 alone starts the drive at "pre-set speed" 1= Both DIN1 and DIN2 has to be activated before the drive will start and run at the speed set in <a href="#">P2.1.20</a>
P2.2.2	DIN3 function	0	12		11		301	0=Not used 1=External fault cc 2=External fault oc 3=Run enable 4= CP: I/O terminal 5= CP: Keypad 6= CP: Fieldbus 7=Pre set speed 8=Fault reset 9=Acc./Dec.operation prohibit 10= DC braking command 11= Enable PID reference 2 12 = Run disable
P2.2.3	DIN4 function	0	12		8		1509	See above
P2.2.4	DIN5 function	0	12		12		330	See above
P2.2.5	Fieldbus control reference selection	1	6		5		122	1=AI2 2=AI3 3=AI4 4=Panel reference 5=FB reference 6=PID controller
P2.2.6	Actual value selection	0	7		0		333	0=Actual value 1 1=Actual 1 + Actual 2 2=Actual 1 - Actual 2 3=Actual 1 * Actual 2 4=Min[Actual 1, Actual 2] 5=Max[Actual 1, Actual 2] 6=Mean[Actual1, Actual2] 7=.Sqrt (Act1) + Sqrt (Act2)
P2.2.7	Actual value 1 input	0	5		2		334	0=Not used 1=AI1 signal (c-board) 2=AI2 signal (c-board) 3=AI3 signal 4=AI4 signal 5=Fieldbus (FBProcessDataIN2)
P2.2.8	Actual value 2 input	0	5		0		335	0=Not used 1=AI1 signal (c-board) 2=AI2 signal (c-board) 3=AI3 signal 4=AI4 signal 5=Fieldbus (FBProcessDataIN3)
P2.2.9	Actual value 1 minimum scale	-320,00	320,00	%	0,00		336	0=No minimum scaling
P2.2.10	Actual value 1 maximum scale	-320,00	320,00	%	100,00		337	100=No maximum scaling
P2.2.11	Actual value 2 minimum scale	-320,00	320,00	%	0,00		338	0=No minimum scaling

P2.2.12	Actual value 2 maximum scale	-320,00	320,00	%	100,00		339	100=No maximum scaling
P2.2.13	AI1 Signal select	0			A.1		1532	
P2.2.14	AI1 signal range	0	2		0		320	0=Signal range 0—10V 1=Signal range 2—10V 2=Custom range
P2.2.15	AI1 custom minimum setting	0,00	100,00	%	0,00		321	
P2.2.16	AI1 custom maximum setting	0,00	100,00	%	100,00		322	
P2.2.17	AI1 inversion	0	1		0		323	0=Not inverted 1=Inverted
P2.2.18	AI1 filter time	0,00	10,00	s	0,10		324	0=No filtering
P2.2.19	AI2 Signal select	0			A.2		1533	
P2.2.20	AI2 signal range	0	2		1		325	0=0—20 mA 1=4—20 mA 2=Customised
P2.2.21	AI2 custom minimum setting	0,00	100,00	%	0,00		326	
P2.2.22	AI2 custom maximum setting	0,00	100,00	%	100,00		327	
P2.2.23	AI2 inversion	0	1		0		328	0=Not inverted 1=Inverted
P2.2.24	AI2 filter time	0,00	10,00	s	0,10		329	0=No filtering
P2.2.25	PID minimum limit	-100,00	Par. 2.2.29	%	0,00		359	
P2.2.26	PID maximum limit	Par. 2.2.28	100,00	%	100,00		360	
P2.2.27	Error value inversion	0	1		0		340	0=No inversion 1=Inversion
P2.2.28	PID reference rising time	0,1	100,0	s	5,0		341	
P2.2.29	PID reference falling time	0,1	100,0	s	5,0		342	
P2.2.30	Easy changeover	0	1		0		366	0=Keep reference 1=Copy actual reference
P2.2.31	AI3 Signal select	0			0.1		141	
P2.2.32	AI3 Signal range	0	1		1		143	
P2.2.33	AI3 inversion	0	1		0		151	0=Not inverted 1=Inverted
P2.2.34	AI3 filter time	0,00	10,00	s	0,10		142	0=No filtering
P2.2.35	AI4 Signal select	0			0.1		152	
P2.2.36	AI4 Signal range	0	1		1		154	
P2.2.37	AI4 inversion	0	1		0		162	0=Not inverted 1=Inverted
P2.2.38	AI4 filter time	0,00	10,00	s	0,10		153	0=No filtering
P2.2.39	Follower filter time	0,00	10,00	s	0,10		1550	0=No filtering
P2.2.40	Follower inversion	0	1		0		1552	0=Not inverted 1=Inverted

Table 31. Input signals, G2.2

CP=control place, cc=closing contact, oc=opening contact

#### 4.7.4 Output signals (Control keypad: Menu M2 → G2.3)

Code	Parameter	Min	Max	Unit	Default	Cust	ID	Note
P2.3.1	Analogue output filter time	0,00	10,00	s	1,00		308	
P2.3.2	Analogue output inversion	0	1		0		309	0=Not inverted 1=Inverted
P2.3.3	Analogue output minimum	0	1		0		310	0=0 V 1=2 V
P2.3.4	Analogue output scale	10	1000	%	100		311	
P2.3.5	Output frequency limit 1 supervision	0	2		0		315	0=No limit 1=Low limit supervision 2=High limit supervision
P2.3.6	Output frequency limit 1; Supervised value	0,00	Par. 2.1.2	Hz	0,00		316	
P2.3.7	Output frequency limit 2 supervision	0	2		0		346	0=No limit 1=Low limit supervision 2=High limit supervision
P2.3.8	Output frequency limit 2; Supervised value	0,00	Par. 2.1.2	Hz	0,00		347	
P2.3.9	Torque limit supervision	0	2		0		348	0=Not used 1=Low limit supervision 2=High limit supervision
P2.3.10	Torque limit supervision value	0,0	300,0	%	100,0		349	
P2.3.11	FC temperature supervision	0	2		0		354	0=Not used 1=Low limit 2=High limit
P2.3.12	FC temperature supervised value	-10	100	°C	40		355	
P2.3.13	Actual value supervision to relay	0	100,00	%	0,00		1541	
P2.3.14	Actual value over / under supervised value to relay	0	2		0		1542	0=Not used 1=Over supervised value 2=Under supervised value
P2.3.15	lout2 signal	0			0.1		471	
P2.3.16	lout2 content	0	13		7		472	
P2.3.17	lout2 filter time	0,00	10,00	s	1,00		473	
P2.3.18	lout2 invert	0	1		0		474	
P2.3.19	lout2 minimum	0	1		0		475	
P2.3.20	lout2 scale	10	1000	%	0		476	
P2.3.21	lout3 signal	0			0.1		1534	
P2.3.22	lout3 content	0	13		0		1535	
P2.3.23	lout3 filter time	0,00	10,00	s	0,00		1536	
P2.3.24	lout3 invert	0	1		0		1527	
P2.3.25	lout3 minimum	0	1		0		1538	
P2.3.26	lout3 scale	10	1000	%	0		1539	

Table 32. Output signals, G2.3

#### 4.7.5 Delayed Output signals R01 and R02 (Control keypad: Menu M2 → G2.3.28)

Code	Parameter	Min	Max	Unit	Default	Cust	ID	Note
P2.3.28.1	R01 Signal	0			0.1		1524	
P2.3.28.2	R01 Content		16		2		1525	0=Not used 1=Ready 2=Run 3=Fault 4=Fault inverted 5=Warning 6=External fault or warning 7=Reference fault or warning 8=Vacon overheat warning 9=Preset speed 10=Output freq. limit sup. 1 11=Output freq. limit sup. 2 12=Thermistor fault/warning 13=Torque limit supervision 14=Motor thermal fault warn 15=Motor reg. activated 16=Act. value limit superv.
P2.3.28.3	R01 On delay	0,00	320,00	s	0,00		1526	
P2.3.28.4	R01 Off delay	0,00	320,00	s	0,00		1527	
P2.3.28.5	R02 Signal	0			B.2		1528	
P2.3.28.6	R02 Content	0	16		3		1529	See P2.3.28.2
P2.3.28.7	R02 On delay	0	320,00	s	0,00		1530	
P2.3.28.8	R02 Off delay	0	320,00	s	0,00		1531	

Table 33. Delayed output signals, G2.3.28

#### 4.7.6 Relay outputs (Control keypad: Menu M2 → G2.3.29)

Code	Parameter	Min	Max	Default	Cust	ID	Note
P2.3.29.1	Ready	0		A.1		432	
P2.3.29.2	Run	0		B.1		433	
P2.3.29.3	Fault	0		B.2		434	
P2.3.29.4	Fault, inverted	0		0.2		435	
P2.3.29.5	Warning	0		0.1		436	
P2.3.29.6	External fault/warning	0		0.1		437	
P2.3.29.7	AI ref fault/warning	0		0.1		438	
P2.3.29.8	Overtemp warning	0		0.1		439	
P2.3.29.9	Preset speed	0		0.1		443	
P2.3.29.10	FreqOut superv.limit1	0		0.1		447	
P2.3.29.11	FreqOut superv.limit2	0		0.1		448	
P2.3.29.12	Temp lim superv	0		0.1		450	
P2.3.29.13	Torq limit superv	0		0.1		451	
P2.3.29.14	Motor term fault/warn	0		0.1		452	
P2.3.29.15	Motor reg active	0		0.1		454	
P2.3.29.16	Actual value superv	0		0.1		1523	

Table 34. Relay output signals, G2.3.29

#### 4.7.7 Drive control parameters (Control keypad: Menu M2 → G2.4)

Code	Parameter	Min	Max	Unit	Default	Cust	ID	Note
P2.4.1	Ramp 1 shape	0,1	10,0	s	0,0		500	0=Linear >0=S-curve ramp time
P2.4.2	Ramp 2 shape	0,1	10,0	s	0,0		501	0=Linear >0=S-curve ramp time
P2.4.3	Acceleration time 2	0,1	3000,0	s	5,0		502	
P2.4.4	Deceleration time 2	0,1	3000,0	s	5,0		503	
P2.4.5	Brake chopper	0	3		0		504	0=Disabled 1=Used and tested in Run state 2=External brake chopper 3=Used and tested in Ready state
P2.4.6	Start function	0	1		0		505	0=Ramp 1=Flying start
P2.4.7	Stop function	0	3		1		506	0=Coasting 1=Ramp 2=Ramp+Run enable coast 3=Coast+Run enable ramp
P2.4.8	DC braking current	0,00	$I_L$	A	$0,7 \times I_H$		507	
P2.4.9	DC braking time at stop	0,00	60,00	s	0,00		508	0=DC brake is off at stop
P2.4.10	Frequency to start DC braking during ramp stop	0,10	10,00	Hz	0,00		515	
P2.4.11	DC braking time at start	0,00	60,00	s	0,00		516	0=DC brake is off at start
P2.4.12	Flux brake	0	1		0		520	0=Off 1=On
P2.4.13	Flux braking current	0,00	$I_L$	A	$I_H$		519	

Table 35. Drive control parameters, G2.4

#### 4.7.8 Prohibit frequency parameters (Control keypad: Menu M2 → G2.5)

Code	Parameter	Min	Max	Unit	Default	Cust	ID	Note
P2.5.1	Prohibit frequency range 1 low limit	0,0	Par. 2.5.2	Hz	0,0		509	0=Not used
P2.5.2	Prohibit frequency range 1 high limit	0,0	Par. 2.1.2	Hz	0,0		510	0=Not used
P2.5.3	Prohibit frequency range 2 low limit	0,0	Par. 2.5.4	Hz	0,0		511	0=Not used
P2.5.4	Prohibit frequency range 2 high limit	0,0	Par. 2.1.2	Hz	0,0		512	0=Not used
P2.5.5	Prohibit frequency range 3 low limit	0,0	Par. 2.5.6	Hz	0,0		513	0=Not used
P2.5.6	Prohibit frequency range 3 high limit	0,0	Par. 2.1.2	Hz	0,0		514	0=Not used
P2.5.7	Prohibit frequencies acc./dec. ramp scaling	0,1	10,0	Times	1,0		518	

Table 36. Prohibit frequency parameters, G2.5



#### 4.7.9 Motor control parameters (Control keypad: Menu M2 → G2.6)

Code	Parameter	Min	Max	Unit	Default	Cust	ID	Note
P2.6.1	Motor control mode	0	1		0		600	0=Frequency control 1=Speed control
P2.6.2	U/f optimisation	0	1		0		109	0=Not used 1=Automatic torque boost
P2.6.3	U/f ratio selection	0	3		0		108	0=Linear 1=Squared 2=Programmable 3=Linear with flux optim.
P2.6.4	Field weakening point	30,00	320,00	Hz	50,00		602	
P2.6.5	Voltage at field weakening point	10,00	200,00	%	100,00		603	$n\% \times U_{nmot}$
P2.6.6	U/f curve midpoint frequency	0,00	par. P2.6.4	Hz	50,00		604	
P2.6.7	U/f curve midpoint voltage	0,00	100,00	%	100,00		605	$n\% \times U_{nmot}$ Parameter max. value = par. 2.6.5
P2.6.8	Output voltage at zero frequency	0,00	40,00	%	Varies		606	$n\% \times U_{nmot}$
P2.6.9	Switching frequency	1,0	16,0	kHz	Varies		601	Depends on kW
P2.6.10	Overvoltage controller	0	1		1		607	0=Not used 1=Used (no ramping) 2=Used (ramping)
P2.6.11	Undervoltage controller	0	1		1		608	0=Not used 1=Used (no ramping) 2=Used (ramping)

Table 37. Motor control parameters, G2.6

## 4.7.10 Protections (Control keypad: Menu M2 → G2.7)

Code	Parameter	Min	Max	Unit	Default	Cust	ID	Note
P2.7.1	Response to reference fault	0	5		4		700	0=No response 1=Warning 2=Warning+Old Freq. 3=Wrrng+PresetFreq 2.7.2 4=Fault,stop acc. to 2.4.7 5=Fault,stop by coasting
P2.7.2	Reference fault frequency	0,00	Par. 2.1.2	Hz	0,00		728	
P2.7.3	Response to external fault	0	3		2		701	0=No response 1=Warning 2=Fault,stop acc. to 2.4.7 3=Fault,stop by coasting
P2.7.4	Input phase supervision	0	3		2		730	
P2.7.5	Response to undervoltage fault	1	3		1		727	
P2.7.6	Output phase supervision	0	3		2		702	
P2.7.7	Earth fault protection	0	3		2		703	
P2.7.8	Thermal protection of the motor	0	3		2		704	
P2.7.9	Motor ambient temperature factor	-100,0	100,0	%	0,0		705	
P2.7.10	Motor cooling factor at zero speed	0,0	150,0	%	40,0		706	
P2.7.11	Motor thermal time constant	1	200	min	Varies		707	
P2.7.12	Motor duty cycle	0	100	%	100		708	
P2.7.13	Stall protection	0	3		2		709	0=No response 1=Warning 2=Fault,stop acc. to 2.4.7 3=Fault,stop by coasting
P2.7.14	Stall current	0,00	$2 \times I_H$	A	$I_H$		710	
P2.7.15	Stall time limit	1,00	120,00	s	15,00		711	
P2.7.16	Stall frequency limit	1,0	Par. 2.1.2	Hz	25,0		712	
P2.7.17	Underload protection	0	3		0		713	0=No response 1=Warning 2=Fault,stop acc. to 2.4.7 3=Fault,stop by coasting
P2.7.18	Underload curve at nominal frequency	10	150	%	50		714	
P2.7.19	Underload curve at zero frequency	5,0	150,0	%	10,0		715	
P2.7.20	Underload protection time limit	2	600	s	20		716	
P2.7.21	Thermistor fault resp	0	3		0		732	0=No action 1=Warning 2=Fault 3=Fault, coast
P2.7.22	FB comm. fault	0	3		2		733	Response to fieldbus fault 0=No action 1=Warning 2=Fault 3=Fault, coast

P2.7.23	Slot comm. fault	0	3		2		734	Response to option card fault 0=No action 1=Warning 2=Fault 3=Fault, coast
P2.7.24	Value of actual value supervision	0,00	100,00	%	0,00		1518	
P2.7.25	Actual value over/under supervision value	0	2		0		1519	0=No action 1=Over 2=Under
P2.7.26	Actual value supervision response	0	3		0		1522	Response to Actual value supervision 0=No action 1=Warning 2=Fault 3=Fault, coast
P2.7.27	Actual value response time	0	300	s	1		1540	

Table 38. Protections, G2.7

#### 4.7.11 Autorestart parameters (Control keypad: Menu M2 → G2.8)

Code	Parameter	Min	Max	Unit	Default	Csut	ID	Note
P2.8.1	Wait time	0,10	10,00	s	0,50		717	
P2.8.2	Trial time	0,00	60,00	s	30,00		718	
P2.8.3	Start function	0	2		0		719	0=Ramp 1=Flying start 2=According to par. 2.4.6
P2.8.4	Number of tries after undervoltage trip	0	10		2		720	
P2.8.5	Number of tries after overvoltage trip	0	10		2		721	
P2.8.6	Number of tries after overcurrent trip	0	3		2		722	
P2.8.7	Number of tries after reference trip	0	10		1		723	
P2.8.8	Number of tries after motor temperature fault trip	0	10		0		726	
P2.8.9	Number of tries after external fault trip	0	10		0		725	

Table 39. Autorestart parameters, G2.8

#### 4.8 Keypad control (Control keypad: Menu M3)

The parameters for the selection of control place and direction on the keypad are listed below. See the Keypad control menu in the product's User's Manual.

Code	Parameter	Min	Max	Unit	Default	Cust	ID	Note
P3.1	Control place	1	3		1		125	1=I/O terminal 2=Keypad 3=Fieldbus
R3.2	Keypad reference	Par. 2.1.1	Par. 2.1.2	Hz				
R3.3	PID reference 1	0,00	100,00	%	40,00		167	
R3.4	PID reference 2	0,00	100,00	%	0,00		168	
R3.5	Stop Button	0	1		0		114	

Table 40. Keypad control parameters, M3

#### 4.9 Expander boards (Control keypad: Menu M7)

The **M7** menu shows the expander and option boards attached to the control board and board-related information. For more information, see the product's User's Manual.

## 5. DESCRIPTION OF PARAMETERS

On the following pages you will find the parameter descriptions arranged according to the individual ID number of the parameter. A shaded parameter ID number (e.g. **432 Ready**) indicates that the *TTF programming method* shall be applied to this parameter.

**NOTE!** The digital output (A.1) on the basic I/O board OPT-A1 is reserved for communication in the MultiMaster PFC, Advanced Level Control and MultiFollower PFC applications.

Some parameter names are followed by a number code indicating the "All in One" applications in which the parameter is included. If **no code** is shown the parameter is available in **all applications**. See below. The parameter numbers under which the parameter appears in different applications are also given.

- 1 *Basic Application*
- 2 *MultiMaster PFC Application*
- 3 *Advanced Level Control Application*
- 4 *MultiFollower PFC Application*

- 101 *Minimum frequency* 1 (2.1)
- 102 *Maximum frequency* 1 (2.2)

Defines the frequency limits of the frequency converter.

The maximum value for these parameters is 320 Hz.

The software will automatically check the values of parameters ID105, ID106, [ID315](#) and [ID728](#).

- Null /Maximum Producing limit* 234 (2.1.1, 2.1.2)

Defines the frequency limits of the frequency converter.

The maximum value for parameters ID101 and ID102 is 320 Hz.

The software will automatically check the values of parameters [ID316](#) and [ID728](#)

The parameters also defines:

ID101 *Null producing limit / Min output freq. / Lower change freq. / Sleep freq.*

ID102 *Max producing limit / Max output freq. / Upper change freq.*

The frequency converter is stopped automatically if the frequency of the drive falls below the *Sleep frequency* defined with this parameter, for a time greater than that determined by parameter [ID1017](#). During the Stop state, the PID controller switches the frequency converter to Run state when the signal of the actual value either falls below or exceeds the *Wake-up level*, par. [ID1018](#) (depending on the *Wake-up action*, par. [ID1019](#))

- 103 *Acceleration time 1* (2.3,2.1.3)
- 104 *Deceleration time 1* (2.4, 2.1.4)

These limits correspond to the time required for the output frequency to accelerate from the zero frequency to the set maximum frequency (par. ID102).

- 105 *Preset speed 1* 1 (2.18)  
 106 *Preset speed 2* 1 (2.19)

Parameter values are automatically limited between the minimum and maximum frequencies (par. ID101, ID102).

Speed	Multi-step speed sel. 1 (DIN4)	Multi-step speed sel. 2 (DIN5)
Basic speed	0	0
ID105	1	0
ID106	0	1

Table 41. Preset speed

- 107 *Current limit* (2.5, 2.1.5)

This parameter determines the maximum motor current from the frequency converter. The parameter value range differs from size to size.

- 108 *U/f ration selection* 234 (2.6.3)

Linear: 0 The voltage of the motor changes linearly with the frequency in the constant flux area from 0 Hz to the field weakening point where the nominal voltage is supplied to the motor. Linear U/f ration should be used in constant torque applications. **This default setting should be used if there is no special need for another setting.**

Squared: 1 The voltage of the motor changes following a squared curve form with the frequency in the area from 0 Hz to the field weakening point where the nominal voltage is also supplied to the motor. The motor runs undermagnetised below the field weakening point and produces less torque and electro-mechanical noise. Squared U/f ratio can be used in applications where torque demand of the load is proportional to the square of the speed, e.g. in centrifugal fans and pumps.

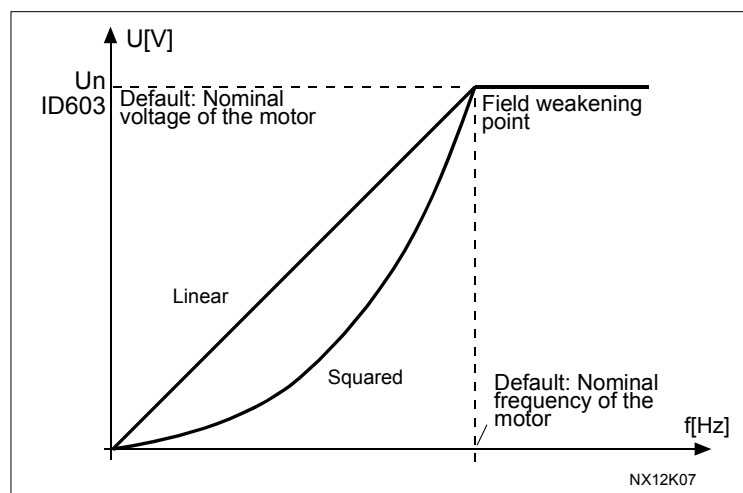

Figure 22. Linear and squared change of motor voltage

Programmable U/f curve:

- 2 The U/f curve can be programmed with three different points. Programmable U/f curve can be used if the other settings do not satisfy the needs of the application.

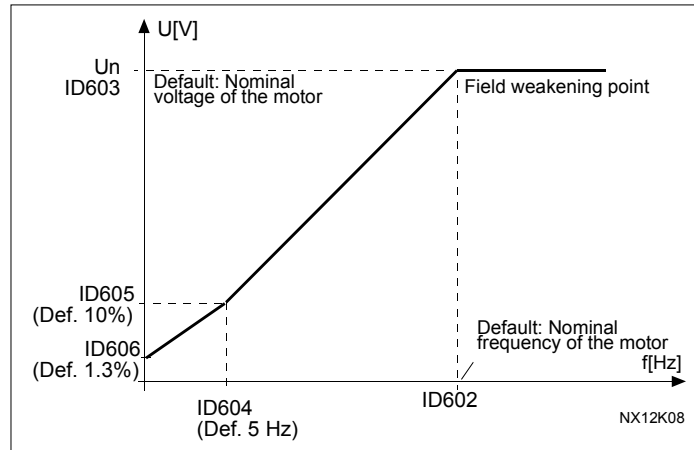

Figure 23. Programmable U/f curve

Linear with flux optimisation:

- 3 The frequency converter starts to search for the minimum motor current in order to save energy, lower the disturbance level and the noise. This function can be used in applications with constant motor load, such as fans, pumps etc.

## 109 *U/f optimisation (2.13, 2.6.2)*

**Automatic torque boost** The voltage to the motor changes automatically which makes the motor produce sufficient torque to start and run at low frequencies. The voltage increase depends on the motor type and power. Automatic torque boost can be used in applications where starting torque due to starting friction is high, e.g. in conveyors.

### EXAMPLE:

What changes are required to start with load from 0 Hz?

- ◆ First set the motor nominal values (Parameter group 2.1).

Option 1: Activate the Automatic torque boost.

Option 2: Programmable U/f curve

To get torque you need to set the zero point voltage and midpoint voltage/frequency (in parameter group 2.6) so that the motor takes enough current at low frequencies.

First set par. ID108 to *Programmable U/f curve* (value 2). Increase zero point voltage (ID606) to get enough current at zero speed. Set then the midpoint voltage (ID605) to  $1.4142 \cdot ID606$  and midpoint frequency (ID604) to value  $ID606/100\% \cdot ID111$ .

*NOTE! In high torque – low speed applications – it is likely that the motor will overheat. If the motor has to run a prolonged time under these conditions, special attention must be paid to cooling the motor. Use external cooling for the motor if the temperature tends to rise too high.*

**110 Nominal voltage of the motor** (2.6, 2.1.6)

Find this value  $U_n$  on the rating plate of the motor. This parameter sets the voltage at the field weakening point (ID603) to  $100\% \cdot U_{nMotor}$ .

**111 Nominal frequency of the motor** (2.7, 2.1.7)

Find this value  $f_n$  on the rating plate of the motor. This parameter sets the field weakening point (ID602) to the same value.

**112 Nominal speed of the motor** (2.8, 2.1.8)

Find this value  $n_n$  on the rating plate of the motor.

**113 Nominal current of the motor** (2.9, 2.1.9)

Find this value  $I_n$  on the rating plate of the motor.

**117 I/O frequency reference selection** 1 (2.14)

Defines which frequency reference source is selected when controlled from the I/O control place.

Applic. Sel.	1
0	Analogue volt.ref. Terminals 2-3
1	Analogue curr.ref. Terminals 4-5
2	Keypad reference (Menu M3)
3	Fieldbus reference

Table 42. Selections for parameter ID117

**118 PID controller gain** 234 (2.1.12)

This parameter defines the gain of the PID controller. If the value of the parameter is set to 100% a change of 10% in the error value causes the controller output to change by 10%. If the parameter value is set to 0 the PID controller operates as ID-controller. See examples on page 81.



**119**      ***PID controller I-time***                      **234**    *(2.1.13)*

The parameter ID119 defines the integration time of the PID controller. If this parameter is set to 1,00 second a change of 10% in the error value causes the controller output to change by 10.00%/s. If the parameter value is set to 0.00 s the PID controller will operate as PD controller.

See examples on page 81.

**120**      ***Motor cos phi***                                      *(2.10, 2.1.10)*

Find this value "cos phi" on the rating plate of the motor.

**122**      ***Fieldbus frequency reference selection***                      **234**    *(2.2.5)*

Defines which frequency reference source is selected when controlled from the fieldbus.

Applic Sel.	2-4
1	AI2
2	AI3
3	AI4
4	Keypad reference (Menu M3)
5	Reference from fieldbus
6	PID controller reference

Table 43. Selections for par. ID122

**124**      ***Preset speed***                                      **234**    *(2.1.20, 2.1.18)*

A frequency that is fed to the motor when DIN2 is activated, or when DIN3, DIN4, DIN5 are activated and value 7 is chosen for parameter **ID301** (*DIN3 Function*), **ID1509** (*DIN4Function*), **ID330** (*DIN5 Function*), or when the START button on the panel is pushed. The parameter value is automatically limited between the minimum and maximum frequencies (**ID's 101 and 102**).

**132**      ***PID controller D-time***                      **234**    *(2.1.14)*

The parameter ID132 defines the derivation time of the PID controller. If this parameter is set to 1,00 second a change of 10% in the error value during 1.00 s causes the controller output to change by 10.00%. If the parameter value is set to 0.00 s the PID controller will operate as PI controller.

See examples below.

**Example 1:**

In order to reduce the error value to zero, with the given values, the frequency converter output behaves as follows:

Given values:

Par. 2.1.12, P = 0%

Par. 2.1.13, I-time = 1.00 s

Par. 2.1.14, D-time = 0.00 s

Min freq. = 0 Hz

Error value (setpoint – process value) = 10.00%      Max freq. = 50 Hz

In this example, the PID controller operates practically as I-controller only.

According to the given value of parameter 2.1.13 (I-time), the PID output increases by 5 Hz (10% of the difference between the maximum and minimum frequency) every second until the error value is 0.

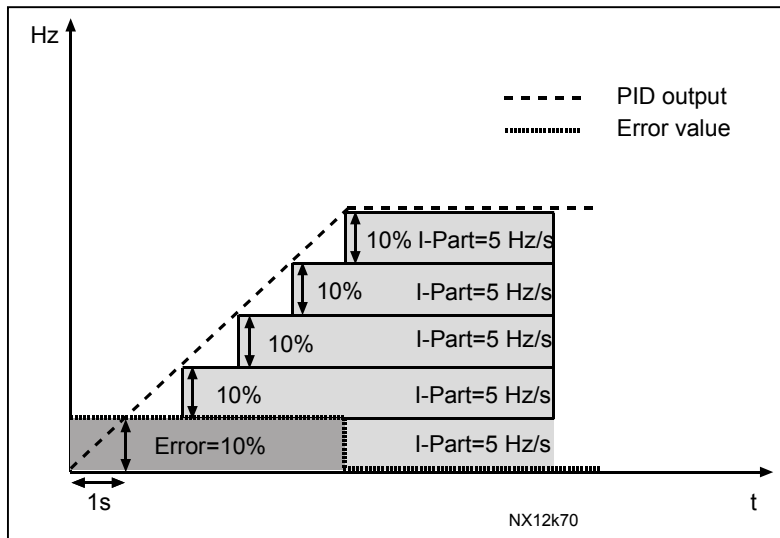

Figure 24. PID controller function as I-controller.

### Example 2:

Given values:

Par. 2.1.12, P = 100%

Par. 2.1.13, I-time = 1.00 s

Par. 2.1.14, D-time = 1.00 s

Error value (setpoint – process value) =  $\pm 10\%$

Min freq. = 0 Hz

Max freq. = 50 Hz

As the power is switched on, the system detects the difference between the setpoint and the actual process value and starts to either raise or decrease (in case the error value is negative) the PID output according to the I-time. Once the difference between the setpoint and the process value has been reduced to 0 the output is reduced by the amount corresponding to the value of parameter 2.1.13.

In case the error value is negative, the frequency converter reacts reducing the output correspondingly. See Figure 25.

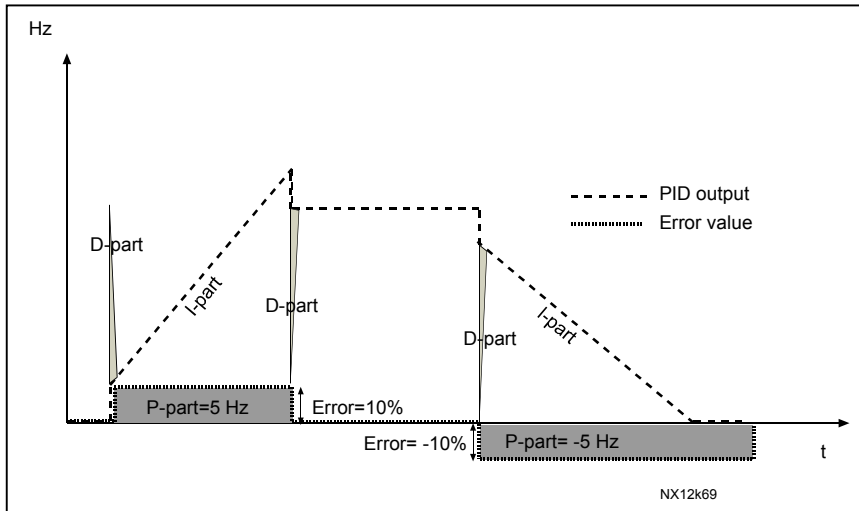

Figure 25. PID output curve with the values of Example 2.

**Example 3:**

Given values:

Par. 2.1.12, P = 100%

Par. 2.1.13, I-time = 0.00 s

Par. 2.1.14, D-time = 1.00 s

Min freq. = 0 Hz

Error value (setpoint – process value) = ±10%/s    Max freq. = 50 Hz

As the error value increases, also the PID output increases according to the set values (D-time = 1.00s)

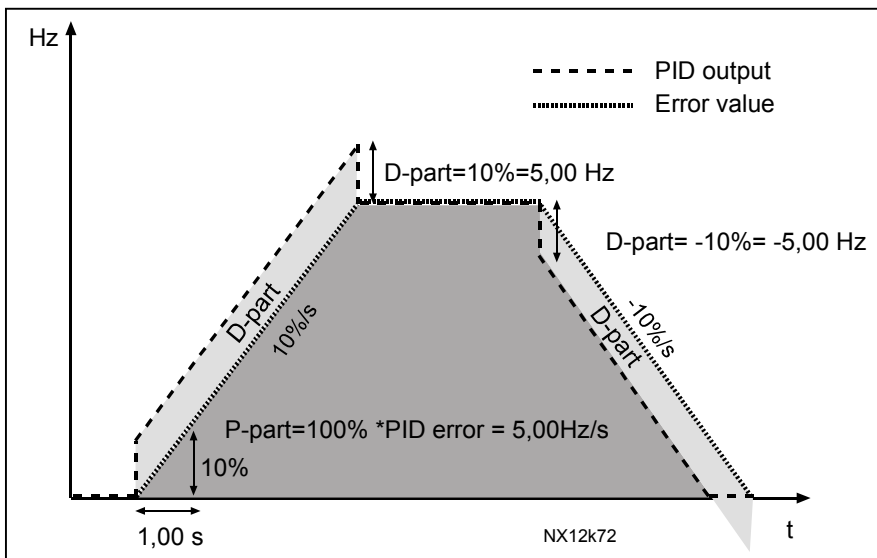

Figure 26. PID output with the values of Example 3.

141

**AI3 signal selection**

234 (2.2.31)

Connect the AI3 signal to the analogue input of your choice with this parameter.

**142**      *AI3 signal filter time*                      **234**    (2.2.34)

When this parameter is given a value greater than 0 the function that filters out disturbances from the incoming analogue signal is activated.  
Long filtering time makes the regulation response slower      . See parameter [ID324](#).

**143**      *AI3 signal range*                      **234**    (2.2.32)

With this parameter you can select the AI3 signal range.

Applic. Sel.	5	6	7
0	0...100%	0...100%	0...100%
1	20...100%	20...100%	20...100%
2		-10...+10V	Customised
3		Customised	

Table 44. Selections for parameter ID143

**151**      *AI3 signal inversion*                                      **234**    (2.2.33)

0 = No inversion  
1 = Signal inverted

**152**      *AI4 signal selection*                                      **234**    (2.2.35)

See ID141.

**153**      *AI4 filter time*                                      **234**    (2.2.38)

See ID142.

**154**      *AI4 signal range*                                      **234**    (2.2.36)

See ID 143.

**162**      *AI4 signal inversion*                                      **234**    (2.2.37)

See ID 151.

<b>301</b>	<i><b>DIN3 function</b></i>	<b>234</b>	(2.17, 2.2.2)
<b>0</b>	Not used		
<b>1</b>	External fault, closing contact =		Fault is shown and motor is stopped when the input is active.
<b>2</b>	External fault, opening contact =		Fault is shown and motor is stopped when the input is not active.
<b>3</b>	Run enable, contact open =		Motor start disabled and the motor is stopped
	contact closed =		Motor start enabled

**Application 1:**

<b>4</b>	Run enable contact open =	Motor start enabled
	contact closed =	Motor start disabled and the motor is stopped

**Applications 2 to 4:**

- 4** Closing contact: Force control place to I/O terminal
- 5** Closing contact: Force control place to keypad
- 6** Closing contact: Force control place to fieldbus

When the control place is forced to change the values of Start/Stop, Direction and Reference valid in the respective control place are used (reference according to parameters [ID122](#))

**Note:** The value of par. [ID125](#) (Keypad Control Place) does not change.

- 7** Preset Speed
- 8** Fault Reset
- 9** Acceleration/Deceleration prohibited  
Contact closed: No acceleration or deceleration possible until the contact is opened
- 10** DC braking command  
Contact closed: In Stop mode, the DC braking operates until the contact is opened.  
See Figure 27.
- 11** PID2 Reference
- 12** Run Disable

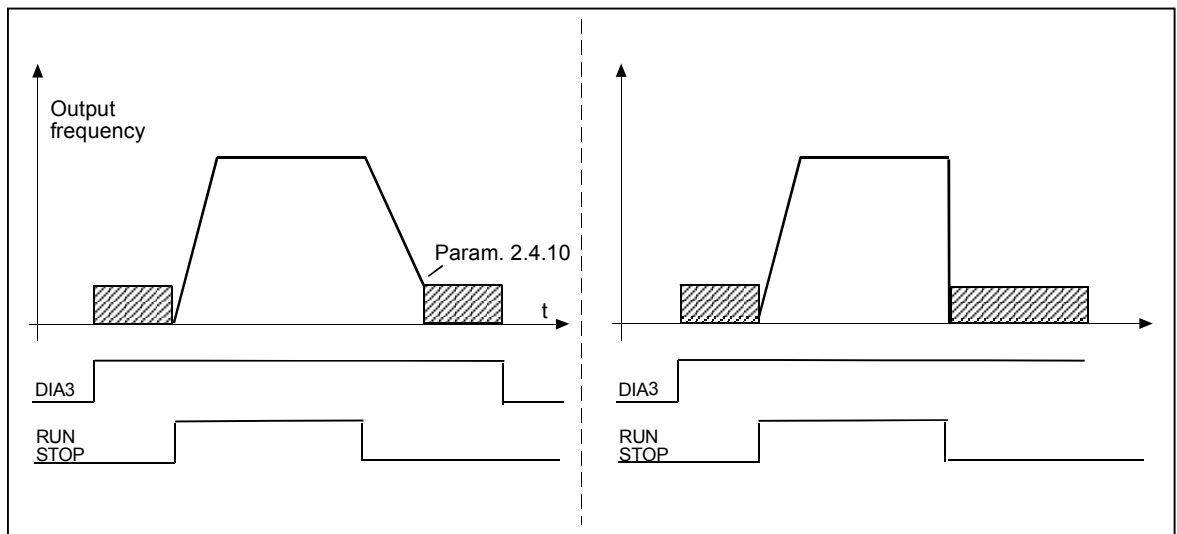

Figure 27. DC braking command (selection 10) selected for DIN3 (or DIN4 or DIN5). Left: Stop mode = Ramp; Right: Stop mode = Coasting

**302**      **Reference offset for current input**                      **1**      (2.15)

0    No offset: 0–20mA

1    Offset 4 mA (“living zero”), provides supervision of zero level signal.

**307**      **Analogue output function**                                      **123**      (2.16, 2.3.1)

This parameter selects the desired function for the analogue output signal.

**Application 1:**

0    Not Used (100%)

1    O/P frequency (0 –  $f_{max}$ )

2    Reference frequency (0 –  $f_{max}$ )

3    Motor Speed (0 – 100% \* Motor nom.speed)

4    O/P current (0 - 100% \*  $I_n$  Mot)

5    Motor torque (0 – 100% \*  $T_n$  Mot)

6    Motor power (0 – 100% \*  $P_n$  Mot)

7    Motor voltage (0 – 100% \*  $U_n$  Mot)

8    DC-link voltage (0 – 100% \*  $U_n$  Mot)

**Applications 2 and 3:**

9    PI-controller reference value

10   PI-controller actual value 1

11   PI-controller actual value 2

12   PI-controller error value

13   PI-controller output

**308**      *Analogue output filter time*      **234**    (2.3.2, 2.3.1)

Defines the filtering time of the analogue output signal.  
Setting this parameter value 0 will deactivate filtering.

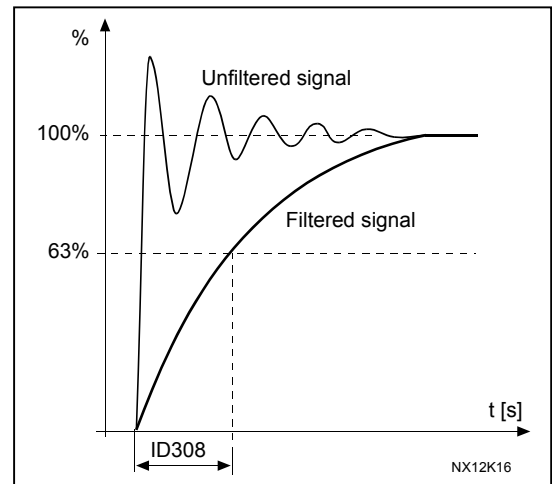

Figure 28. Analogue output filtering

**309**      *Analogue output inversion*      **234**    (2.3.3, 2.3.2)

Inverts the analogue output signal:  
Maximum output signal = Minimum set value  
Minimum output signal = Maximum set value

See parameter [ID311](#).

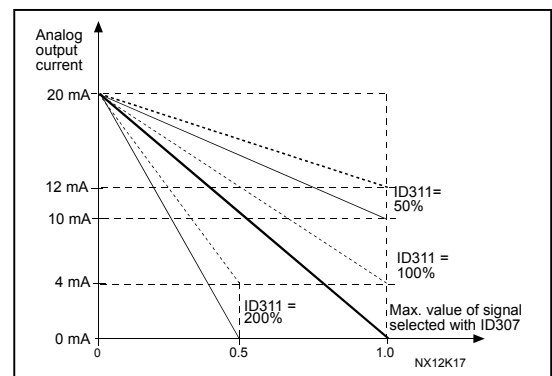

Figure 29. Analogue output invert

**310**      *Analogue output minimum*      **234**    (2.3.4, 2.3.3)

Defines the signal minimum to either 0 mA or 4 mA (living zero). Note the difference in analogue output scaling in parameter [ID311](#) (Figure 30).

- 0 Set minimum value to 0 mA
- 1 Set minimum value to 4 mA

**311** *Analogue output scale 234 (2.3.5, 2.3.4)*

Scaling factor for analogue output.

Signal	Max. value of the signal
Output frequency	Max frequency (par.ID102)
Freq. Reference	Max frequency (par.ID102)
Motor speed	Motor nom. speed $1 \times n_{nMotor}$
Output current	Motor nom. current $1 \times I_{nMotor}$
Motor torque	Motor nom. torque $1 \times T_{nMotor}$
Motor power	Motor nom. power $1 \times P_{nMotor}$
Motor voltage	$100\% \times U_{nMotor}$
DC-link voltage	1000 V
PI-ref. value	$100\% \times \text{ref. value max.}$
PI act. value 1	$100\% \times \text{actual value max.}$
PI act. value 2	$100\% \times \text{actual value max.}$
PI error value	$100\% \times \text{error value max.}$
PI output	$100\% \times \text{output max.}$

Table 45. Analogue output scaling

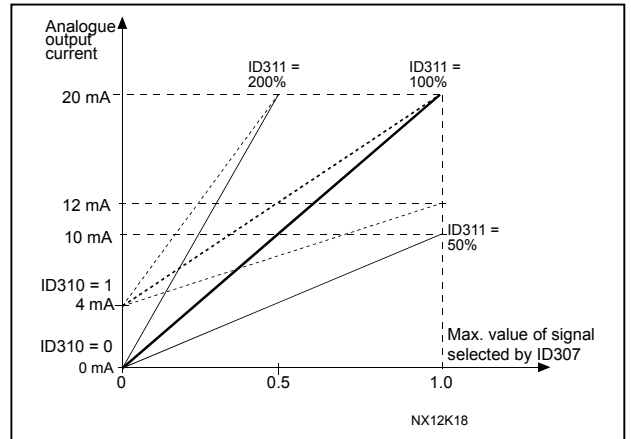

Figure 30. Analogue output scaling

**315** *Output frequency limit supervision function 234 (2.3.6, 2.3.5)*

- 0 No supervision
- 1 Low limit supervision
- 2 High limit supervision

If the output frequency goes below/above the set limit (ID316) this function generates a warning message via the digital output DO1 or via the relay output RO1 or RO2.

**316** *Output frequency limit supervision value 234 (2.3.7, 2.3.6)*

Selects the frequency value supervised by parameter ID315. See Figure 31.

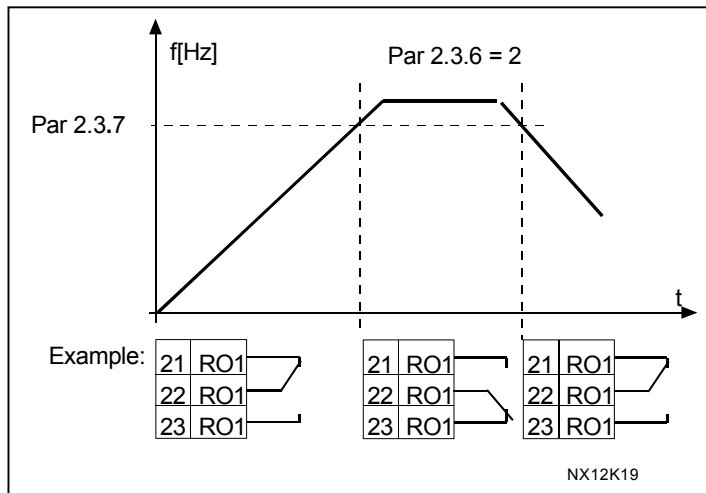

Figure 31. Output frequency supervision



320 *A11 signal range* 234 (2.2.14)

Applic. Sel.	2-4
0	0...100%
1	20...100%
2	Customised

Table 46. Selections for parameter ID320

For selection 'Customised', see parameters ID321 and ID322.

321 *A11 custom setting minimum* 234 (2.2.15)

322 *A11 custom setting maximum* 234 (2.2.16)

These parameters set the analogue input signal for any input signal span within 0...100%.

323 *A11 signal inversion* 234 (2.2.17)

If this parameter = 0, no inversion of analogue  $U_{in}$  signal takes place.

**Note:** In application 3, A11 is place B frequency reference if parameter ID131= 0 (default).

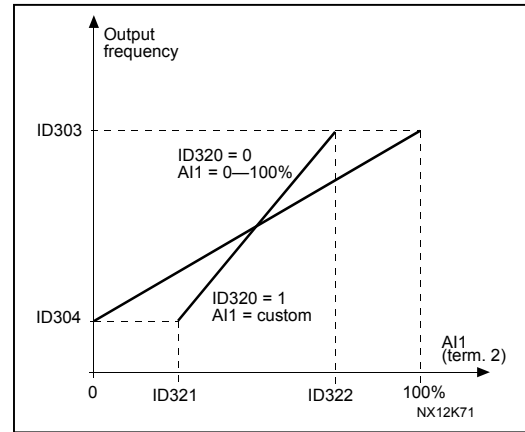

Figure 32. A11 no signal inversion

If this parameter = 1 inversion of analogue signal takes place.  
 max. A11 signal = minimum set speed  
 min. A11 signal = maximum set speed

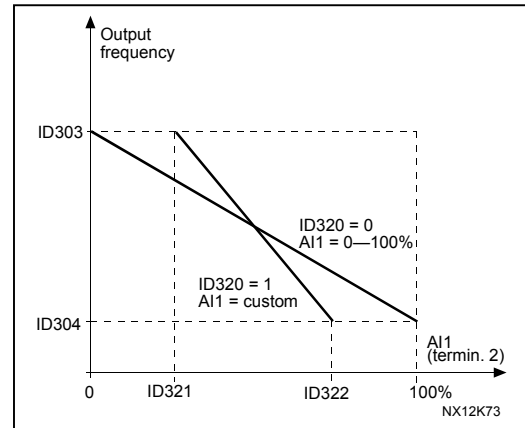

Figure 33. A11 signal inversion

**324**      *A11 signal filter time*                      **234**    (2.2.18)

When this parameter is given a value greater than 0 the function that filters out disturbances from the incoming analogue signal is activated.

Long filtering time makes the regulation response slower. See Figure 34.

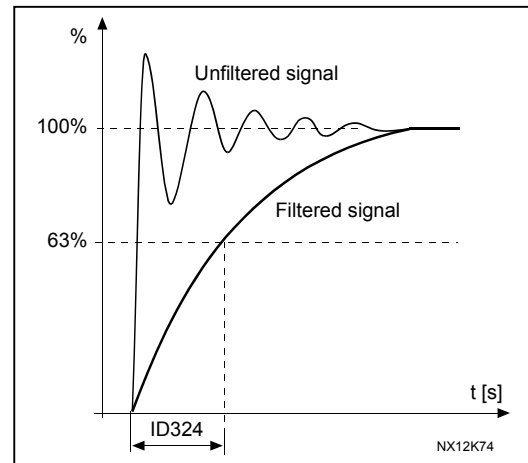

Figure 34. A11 signal filtering

**325**      *Analogue input AI2 signal range*

Applic. Sel.	2-4
0	0...20mA
1	4...20mA
2	Customised

Table 47. Selections for parameter ID325

**234**    (2.2.20)

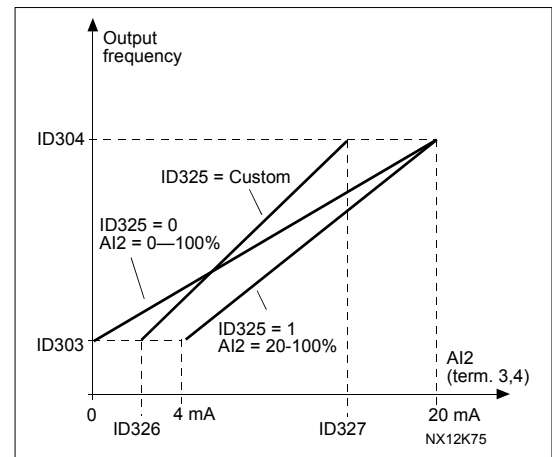

Figure 35. Analogue input AI2 scaling.

**326**      *Analogue input AI2 custom setting min.*                      **234**    (2.2.21)

**327**      *Analogue input AI2 custom setting max.*                      **234**    (2.2.22)

These parameters set AI2 for any input signal span within 0...100%.

**328**      *Analogue input AI2 inversion*                      **234**    (2.2.23)

See ID323.

**329**      *Analogue input AI2 (I<sub>in</sub>) filter time*                      **234**    (2.2.24)

See ID324.

**330**      *DIN5 function*                      **234**    (2.2.4)

See ID301.

**332**      *PID controller reference signal (Place A)*      **234**    (2.1.11)

Defines which frequency reference place is selected for the PID controller.

Applic. Sel.	2-4
1	AI2; terminals 4-5
2	PID ref. from menu M3, par. <a href="#">R34</a>
3	Fieldbus ref. (FBProcessDataIN1)

Table 48. Selections for parameter ID332

**333**      *PID controller actual value selection*      **234**    (2.2.6)

This parameter selects the PID controller actual value.

- 0 Actual value 1
- 1 Actual value 1 + Actual value 2
- 2 Actual value 1 – Actual value 2
- 3 Actual value 1 \* Actual value 2
- 4 Smaller one of Actual value 1 and Actual value 2
- 5 Greater one of Actual value 1 and Actual value 2
- 6 Mean value of Actual value 1 and Actual value 2
- 7 Square root of Actual value 1 + Square root of Actual value 2

**334**      *Actual value 1 selection*      **234**    (2.2.7)**335**      *Actual value 2 selection*      **234**    (2.2.8)

- 0 Not used
- 1 AI1 (control board)
- 2 AI2 (control board)
- 3 AI3
- 4 AI4
- 5 Fieldbus (*Actual value 1*: FBProcessDataIN2; *Actual value 2*: FBProcessDataIN3)

**336**      *Actual value 1 minimum scale*      **234**    (2.2.9)

Sets the minimum scaling point for Actual value 1. See Figure 36.

**337**      *Actual value 1 maximum scale*      **234**    (2.2.10)

Sets the maximum scaling point for Actual value 1. See Figure 36.

**338**      *Actual value 2 minimum scale*      **234**    (2.2.11)

Sets the minimum scaling point for Actual value 2. See Figure 36.

**339**      *Actual value 2 maximum scale*      **234**    (2.2.12)

Sets the maximum scaling point for Actual value 2. See Figure 36.

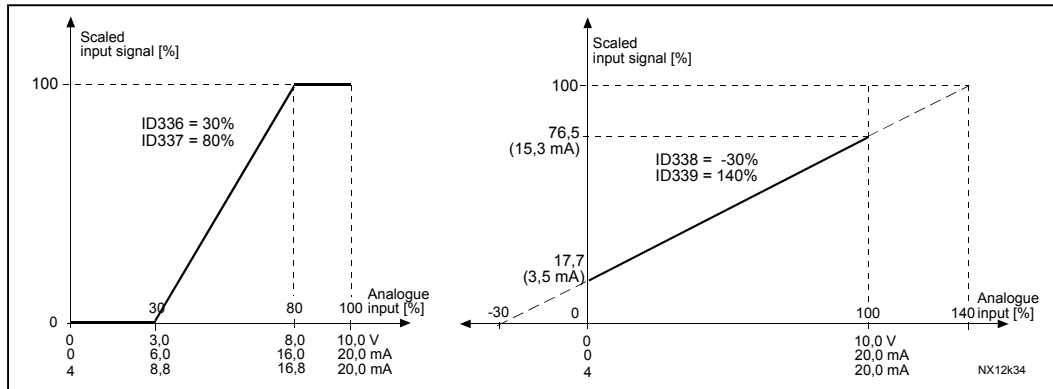

Figure 36. Examples of actual value signal scaling

**340**      *PID error value inversion*                      **234**      (2.2.27)

This parameter allows you to invert the error value of the PID controller (and thus the operation of the PID controller).

- 0 No inversion
- 1 Inverted

**341**      *PID reference rise time*                      **234**      (2.2.28)

Defines the time during which the PID controller reference rises from 0% to 100%.

**342**      *PID reference fall time*                      **234**      (2.2.29)

Defines the time during which the PID controller reference falls from 100% to 0%.

**346**      *Output freq. limit 2 supervision function*                      **234**      (2.3.8)

- 0 No supervision
- 1 Low limit supervision
- 2 High limit supervision

If the output frequency goes below/above the set limit (ID347) this function generates a warning message via the relay output RO1 or RO2 depending on to which output the supervision signals (par. ID447 and ID448) are connected.

**347**      *Output frequency limit 2 supervision value*                      **234**      (2.3.9)

Selects the frequency value supervised by parameter ID346.

**348**      *Torque limit, supervision function*                      **234**      (2.3.10)

- 0 = No supervision
- 1 = Low limit supervision
- 2 = High limit supervision

If the calculated torque value falls below or exceeds the set limit (ID349) this function generates a warning message via relay output RO1 or RO2 depending on which output the supervision signal (par. ID451) is connected.

**349**      *Torque limit, supervision value*                      **234**      (2.3.11)

Set here the torque value to be supervised by parameter ID348.

**354**      *Frequency converter temperature limit supervision 234*      (2.3.12)

- 0 = No supervision
- 1 = Low limit supervision
- 2 = High limit supervision

If the temperature of the frequency converter unit falls below or exceeds the set limit (ID355), this function generates a warning message via a relay output R01 or R02 depending on to which output the supervision signal (par. ID450) is connected.

**355**      *Frequency converter temperature limit value*      **234**      (2.3.13)

This temperature value is supervised by parameter ID354.

**359**      *PID controller minimum limit*      **234**      (2.2.25)**360**      *PID controller maximum limit*      **234**      (2.2.26)

With these parameters you can set the minimum and maximum limits for the PID controller output.

Limit setting:  $-1000.0\%$  (of  $f_{max}$ ) < par. ID359 < par. ID360 <  $1000.0\%$  (of  $f_{max}$ ).

These limits are of importance for example when you define the gain, I-time and D-time for the PID controller.

**366**      *Easy changeover*      **234**      (2.2.30)

- 0 Keep reference
- 1 Copy reference

If Copy reference has been selected it is possible to switch from direct control to PID control and back without scaling the reference and actual value.

For example: The process is driven with direct frequency reference (Fieldbus or keypad) to some point and then the control place is switched to one where the PID controller is selected. The PID control starts to maintain that point. The PID controller error value is forced to zero when the control place is changed.

It is also possible to change the control source back to direct frequency control. In this case, the output frequency is copied as the frequency reference. If the destination place is Keypad the run status (Run/Stop, Direction and Reference) will be copied.

The changeover is smooth when the reference of the destination source comes from the Keypad or an internal motor potentiometer (par. ID332 [PID Ref.] = 2 and ID122 [Fieldbus Ref] = 4).

<b>432</b>	<b><i>Ready</i></b>	<b>234</b>	<b>(2.3.29.1)</b>
	The frequency converter is ready to operate.		
<b>433</b>	<b><i>Run</i></b>	<b>234</b>	<b>(2.3.29.2)</b>
	The frequency converter operates (the motor is running).		
<b>434</b>	<b><i>Fault</i></b>	<b>234</b>	<b>(2.3.29.3)</b>
	A fault trip has occurred. Default programming: B.2.		
<b>435</b>	<b><i>Inverted fault</i></b>	<b>234</b>	<b>(2.3.29.4)</b>
	No fault trip has occurred.		
<b>436</b>	<b><i>Warning</i></b>	<b>234</b>	<b>(2.3.29.5)</b>
	General warning signal.		
<b>437</b>	<b><i>External fault or warning</i></b>	<b>234</b>	<b>(2.3.29.6)</b>
	Fault or warning depending on par. <a href="#">ID701</a> .		
<b>438</b>	<b><i>Reference fault or warning</i></b>	<b>234</b>	<b>(2.3.29.7)</b>
	Fault or warning depending on parameter <a href="#">ID700</a> .		
<b>439</b>	<b><i>Overtemperature warning</i></b>	<b>234</b>	<b>(2.3.29.8)</b>
	The heatsink temperature exceeds +70°C.		
<b>443</b>	<b><i>Preset speed</i></b>	<b>234</b>	<b>(2.3.29.9)</b>
	Preset speed selected.		
<b>447</b>	<b><i>Output frequency limit 1 supervision</i></b>	<b>234</b>	<b>(2.3.29.10)</b>
	The output frequency goes outside the set supervision low limit/high limit (see parameters <a href="#">ID315</a> and <a href="#">ID316</a> )		
<b>448</b>	<b><i>Output frequency limit 2 supervision</i></b>	<b>234</b>	<b>(2.3.29.11)</b>
	The output frequency goes outside the set supervision low limit/high limit (see parameters <a href="#">ID346</a> and <a href="#">ID347</a> )		
<b>450</b>	<b><i>Temperature limit supervision</i></b>	<b>234</b>	<b>(2.3.29.12)</b>
	Frequency converter heatsink temperature goes beyond the set supervision limits (see parameters <a href="#">ID354</a> and <a href="#">ID355</a> ).		
<b>451</b>	<b><i>Torque limit supervision</i></b>	<b>234</b>	<b>(2.3.29.13)</b>
	The motor torque goes beyond the set supervision limits (see parameters <a href="#">ID348</a> and <a href="#">ID349</a> ).		

**452**      *Motor thermal protection*      **234**    (2.3.29.14)

Motor thermistor initiates a overtemperature signal which can be led to a digital output.

**NOTE:** This parameter will not work unless you have Vacon OPT-A3 or OPT-B2 (thermistor relay board) connected.

**454**      *Motor regulator activation*      **234**    (2.3.29.15)

Overvoltage or overcurrent regulator has been activated.

**471**      *Analogue output 2 signal selection*    **234**    (2.3.16)

Connect the A02 signal to the analogue output of your choice with this parameter.

**NOTE!**

The digital output on the basic I/O board (A.1), is reserved for communication in the MultiMaster PFC and Advanced Level Control applications.

**472**      *Analogue output 2 function*      **234**    (2.3.17)**473**      *Analogue output 2 filter time*      **234**    (2.3.18)**474**      *Analogue output 2 inversion*      **234**    (2.3.19)**475**      *Analogue output 2 minimum*      **234**    (2.3.20)**476**      *Analogue output 2 scaling*      **234**    (2.3.21)

For more information on these five parameters, see the corresponding parameters for the analogue output 1 on pages 86 to 88.

500	<b>Acceleration/Deceleration ramp 1 shape</b>	234	(2.4.1)
501	<b>Acceleration/Deceleration ramp 2 shape</b>	234	(2.4.2)

The start and end of acceleration and deceleration ramps can be smoothed with these parameters. Setting value **0** gives a linear ramp shape which causes acceleration and deceleration to act immediately to the changes in the reference signal.

Setting value 0.1...10 seconds for this parameter produces an S-shaped acceleration/deceleration. The acceleration time is determined with parameters [ID103/ID104](#) (ID502/ID503).

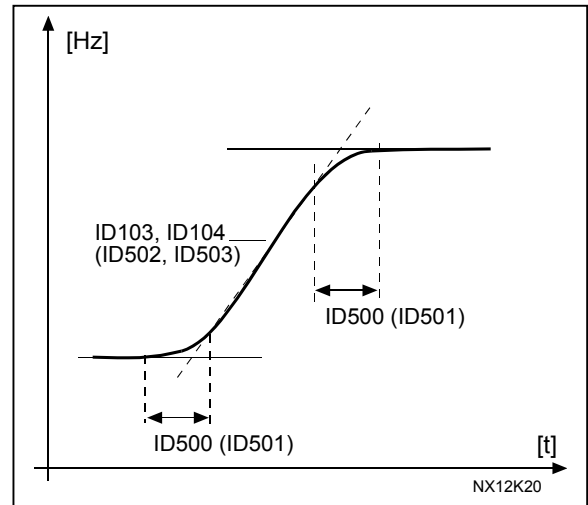

Figure 37. Acceleration/Deceleration (S-shaped)

502	<b>Acceleration time 2</b>	234	(2.4.3)
503	<b>Deceleration time 2</b>	234	(2.4.4)

These values correspond to the time required for the output frequency to accelerate from the zero frequency to the set maximum frequency (par. [ID102](#)). These parameters give the possibility to set two different acceleration/deceleration time sets for one application. The active set can be selected with the programmable signal DIN3 (par. [ID301](#)).

504	<b>Brake chopper</b>	234	(2.4.5)
-----	----------------------	-----	---------

- 0 = No brake chopper used
- 1 = Brake chopper in use and tested when running. Can be tested also in READY state
- 2 = External brake chopper (no testing)
- 3 = Used and tested in READY state and when running

When the frequency converter is decelerating the motor, the inertia of the motor and the load are fed into an external brake resistor. This enables the frequency converter to decelerate the load with a torque equal to that of acceleration (provided that the correct brake resistor has been selected). See separate Brake resistor installation manual.

505	<b>Start function</b>	(2.11, 2.4.6)
-----	-----------------------	---------------

Ramp:

- 0 The frequency converter starts from 0 Hz and accelerates to the set reference frequency within the set [acceleration time](#). (Load inertia or starting friction may cause prolonged acceleration times).

Flying start:

- 1 The frequency converter is able to start into a running motor by applying a small torque to motor and searching for the frequency corresponding to the speed the motor is running at. Searching starts from the maximum frequency towards the actual frequency until the correct value is detected. Thereafter,



the output frequency will be increased/decreased to the set reference value according to the set acceleration/deceleration parameters.

Use this mode if the motor is coasting when the start command is given. With the flying start it is possible to ride through short mains voltage interruptions.

**506**      **Stop function**                      (2.12, 2.4.7)

Coasting:

**0**            The motor coasts to a halt without any control from the frequency converter, after the Stop command.

Ramp:

**1**            After the Stop command, the speed of the motor is decelerated according to the set deceleration parameters.  
If the regenerated energy is high it may be necessary to use an external braking resistor for faster deceleration.

Normal stop: Ramp/ Run Enable stop: coasting

**2**            After the Stop command, the speed of the motor is decelerated according to the set deceleration parameters. However, when Run Enable is selected, the motor coasts to a halt without any control from the frequency converter.

Normal stop: Coasting/ Run Enable stop: ramping

**3**            The motor coasts to a halt without any control from the frequency converter. However, when Run Enable signal is selected, the speed of the motor is decelerated according to the set deceleration parameters. If the regenerated energy is high it may be necessary to use an external braking resistor for faster deceleration.

**507**      **DC-braking current**                      **234**    (2.4.8)

Defines the current injected into the motor during DC-braking.

**508**      **DC-braking time at stop**                      **234**    (2.4.9)

Determines if braking is ON or OFF and the braking time of the DC-brake when the motor is stopping. The function of the DC-brake depends on the stop function, parameter [ID506](#).

**0**            DC-brake is not used

**>0**          DC-brake is in use and its function depends on the Stop function, (param. [ID506](#)). The DC-braking time is determined with this parameter.

**Par. ID506 = 0; Stop function = Coasting:**

After the stop command, the motor coasts to a stop without control of the frequency converter.

With DC-injection, the motor can be electrically stopped in the shortest possible time, without using an optional external braking resistor.

The braking time is scaled according to the frequency when the DC-braking starts. If the frequency is  $\geq$  the nominal frequency of the motor, the set value of parameter ID508

determines the braking time. When the frequency is  $\leq 10\%$  of the nominal, the braking time is 10% of the set value of parameter ID508.

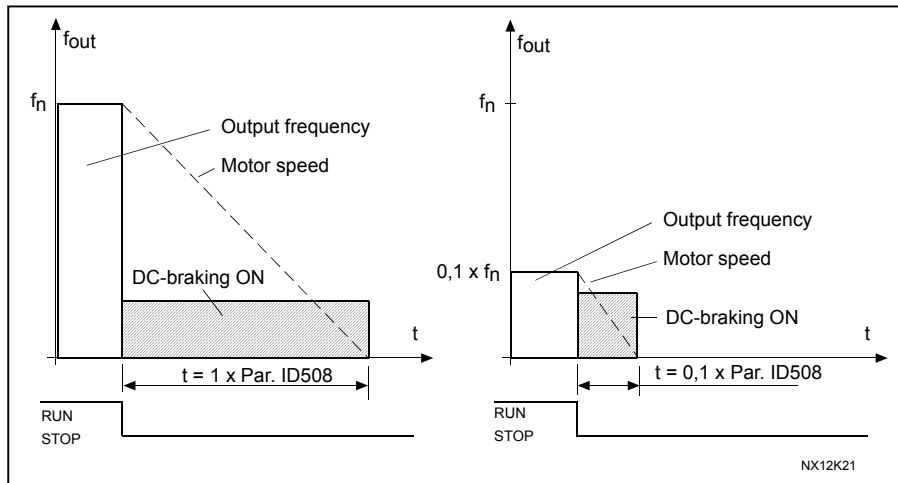

Figure 38. DC-braking time when Stop mode = Coasting.

**Par. ID506 = 1; Stop function = Ramp:**

After the Stop command, the speed of the motor is reduced according to the set deceleration parameters, as fast as possible, to the speed defined with parameter ID515, where the DC-braking starts.

The braking time is defined with parameter ID508. If high inertia exists, it is recommended to use an external braking resistor for faster deceleration. See Figure 39.

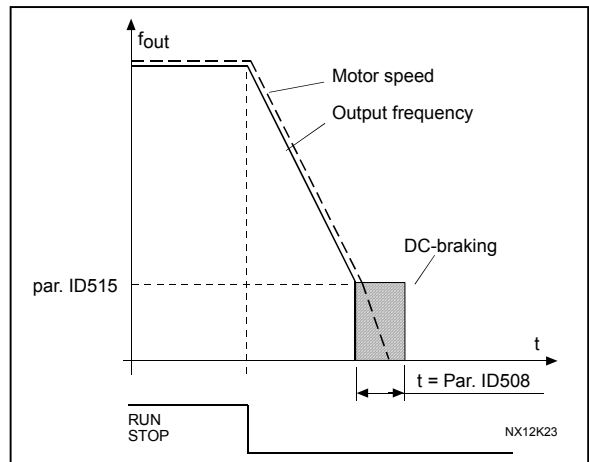

Figure 39. DC-braking time when Stop mode = Ramp

509	<i>Prohibit frequency area 1; Low limit</i>	234	(2.5.1)
510	<i>Prohibit frequency area 1; High limit</i>	234	(2.5.2)
511	<i>Prohibit frequency area 2; Low limit</i>	234	(2.5.3)
512	<i>Prohibit frequency area 2; High limit</i>	234	(2.5.4)
513	<i>Prohibit frequency area 3; Low limit</i>	234	(2.5.5)
514	<i>Prohibit frequency area 3; High limit</i>	234	(2.5.6)

In some systems it may be necessary to avoid certain frequencies because of mechanical resonance problems. With these parameters it is possible to set limits for the "skip frequency" region. See Figure 40.

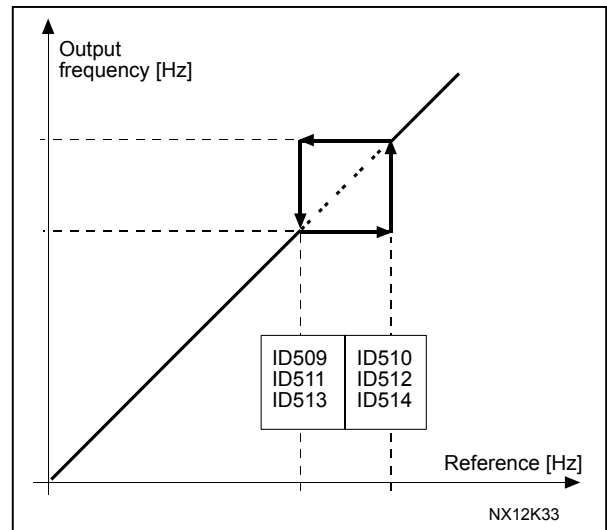

Figure 40. Example of prohibit frequency area setting.

515 *DC-braking frequency at stop* 234 (2.4.10)

The output frequency at which the DC-braking is applied. See Figure 40.

516 *DC-braking time at start* 234 (2.4.11)

DC-brake is activated when the start command is given. This parameter defines the time before the brake is released. After the brake is released, the output frequency increases according to the set start function by parameter [ID505](#).



**600 Motor control mode** **234** (2.6.1)

- 0 Frequency control: The I/O terminal and keypad references are frequency references and the frequency converter controls the output frequency (output frequency resolution = 0.01 Hz)
- 1 Speed control: The I/O terminal and keypad references are speed references and the frequency converter controls the motor speed compensating the motor slip (accuracy  $\pm 0,5\%$ ).

**601 Switching frequency** **234** (2.6.9)

Motor noise can be minimised using a high switching frequency. Increasing the switching frequency reduces the capacity of the frequency converter unit. The range of this parameter depends on the size of the frequency converter:

Type	Min. [kHz]	Max. [kHz]	Default [kHz]
0003–0061 NX_5 0003–0061 NX_2	1.0	16,0	10.0
0072–0520 NX_5	1.0	10.0	3.6
0041–0062 NX_6 0144–0208 NX_6	1.0	6.0	1.5

Table 49. Size-dependent switching frequencies

**602 Field weakening point** **234** (2.6.4)

The field weakening point is the output frequency at which the output voltage reaches the set (ID603) maximum value.

**603 Voltage at field weakening point** **234** (2.6.5)

Above the frequency at the field weakening point, the output voltage remains at the set maximum value. Below the frequency at the field weakening point, the output voltage depends on the setting of the U/f curve parameters. See parameters ID109, ID108, ID604 and ID605.

When the parameters ID110 and ID111 (nominal voltage and nominal frequency of the motor) are set, the parameters ID602 and ID603 are automatically given the corresponding values. If you need different values for the field weakening point and the maximum output voltage, change these parameters **after** setting the parameters ID110 and ID111.

**604 U/f curve, middle point frequency** **234** (2.6.6)

If the programmable U/f curve has been selected with parameter ID108 this parameter defines the middle point frequency of the curve. See Figure 23.

**605**      *U/f curve, middle point voltage*      **234**      (2.6.7)

If the programmable U/f curve has been selected with the parameter ID108 this parameter defines the middle point voltage of the curve. See Figure 23

**606**      *Output voltage at zero frequency*      **234**      (2.6.8)

If the programmable U/f curve has been selected with the parameter ID108 this parameter defines the zero frequency voltage of the curve. NOTE: If the value of par. ID108 is changed this parameter is set to zero. See Figure 23.

**607**      *Overvoltage controller*      **234**      (2.6.10)

These parameters allow the under-/overvoltage controllers to be switched out of operation. This may be useful, for example, if the mains supply voltage varies more than -15% to +10% and the application will not tolerate this over-/undervoltage. In this case, the regulator controls the output frequency taking the supply fluctuations into account.

**0** Controller switched off

**1** Controller switched on (no ramping) = Minor adjustments of OP frequency are made

**608**      *Undervoltage controller*      **234**      (2.6.11)

See par. ID607.

**Note:** Over-/undervoltage trips may occur when controllers are switched out of operation.

**0** Controller switched off

**1** Controller switched on

- 700**      *Response to the 4mA reference fault*      **234**    (2.7.1)
- 0 = No response  
 1 = Warning  
 2 = Warning, the frequency from 10 seconds back is set as reference  
 3 = Warning, the Preset Frequency (Par. [ID728](#)) is set as reference  
 4 = Fault, stop mode after fault according to [ID506](#)  
 5 = Fault, stop mode after fault always by coasting
- A warning or a fault action and message is generated if the 4...20 mA reference signal is used and the signal falls below 3.5 mA for 5 seconds or below 0.5 mA for 0.5 seconds. The information can also be programmed into digital output DO1 or relay outputs RO1 and RO2.
- 701**      *Response to external fault*      **234**    (2.7.3)
- 0 = No response  
 1 = Warning  
 2 = Fault, stop mode after fault according to [ID506](#)  
 3 = Fault, stop mode after fault always by coasting
- A warning or a fault action and message is generated from the external fault signal in the programmable digital inputs DIN3. The information can also be programmed into digital output DO1 and into relay outputs RO1 and RO2.
- 702**      *Output phase supervision*      **234**    (2.7.6)
- 0 = No response  
 1 = Warning  
 2 = Fault, stop mode after fault according to [ID506](#)  
 3 = Fault, stop mode after fault always by coasting
- Output phase supervision of the motor ensures that the motor phases have an approximately equal current.
- 703**      *Earth fault protection*      **234**    (2.7.7)
- 0 = No response  
 1 = Warning  
 2 = Fault, stop mode after fault according to [ID506](#)  
 3 = Fault, stop mode after fault always by coasting
- Earth fault protection ensures that the sum of the motor phase currents is zero. The overcurrent protection is always working and protects the frequency converter from earth faults with high currents.
- 704**      *Motor thermal protection*      **234**    (2.7.8)
- 0 = No response  
 1 = Warning  
 2 = Fault, stop mode after fault according to [ID506](#)  
 3 = Fault, stop mode after fault always by coasting
- If tripping is selected the drive will stop and activate the fault stage. Deactivating the protection, i.e. setting parameter to 0, will reset the thermal stage of the motor to 0%. See chapter 6.1.

**705**      *Motor thermal protection: Motor ambient temp. factor*      **234**      (2.7.9)

The factor can be set between -100.0% and 100.0%. See chapter 6.1.

**706**      *Motor thermal protection: Motor cooling factor at zero speed*      **234**      (2.7.10)

The current can be set to 0...150.0%  $\times I_{nMotor}$ . This parameter sets the value for thermal current at zero frequency. See Figure 42.

The default value is set assuming that there is no external fan cooling the motor. If an external fan is used this parameter can be set to 90% (or even higher).

**Note:** The value is set as a percentage of the motor name plate data, par. [ID113](#) (Nominal current of motor), not the drive's nominal output current. The motor's nominal current is the current that the motor can withstand in direct on-line use without being overheated.

If you change the parameter Nominal current of motor, this parameter is automatically restored to the default value.

Setting this parameter does not affect the maximum output current of the drive which is determined by parameter [ID107](#) alone. See chapter 6.1.

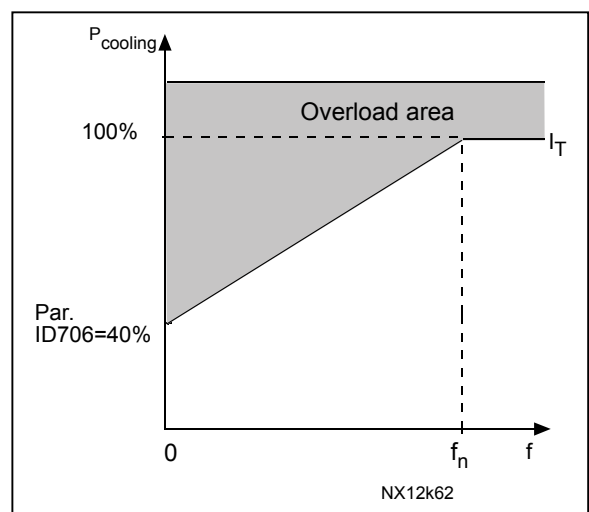

Figure 42. Motor thermal current  $I_T$  curve

**707**      *Motor thermal protection: Time constant*      **234**      (2.7.11)

This time can be set between 1 and 200 minutes.

This is the thermal time constant of the motor. The bigger the motor, the bigger the time constant. The time constant is the time within which the calculated thermal stage has reached 63% of its final value.

The motor thermal time is specific to the motor design and it varies between different motor manufacturers.

If the motor's  $t_6$ -time ( $t_6$  is the time in seconds the motor can safely operate at six times the rated current) is known (given by the motor manufacturer) the time constant parameter can be set basing on it. As a rule of thumb, the motor thermal time constant in minutes equals to  $2 \times t_6$ . If the drive is in stop stage the time constant is internally increased to three times the set parameter value. The cooling in the stop stage is based on convection and the time constant is increased. See also Figure 43.



**708 Motor thermal protection: Motor duty cycle 234 (2.7.12)**

Defines how much of the nominal motor load is applied.  
The value can be set to 0%...100%. See chapter 6.1.

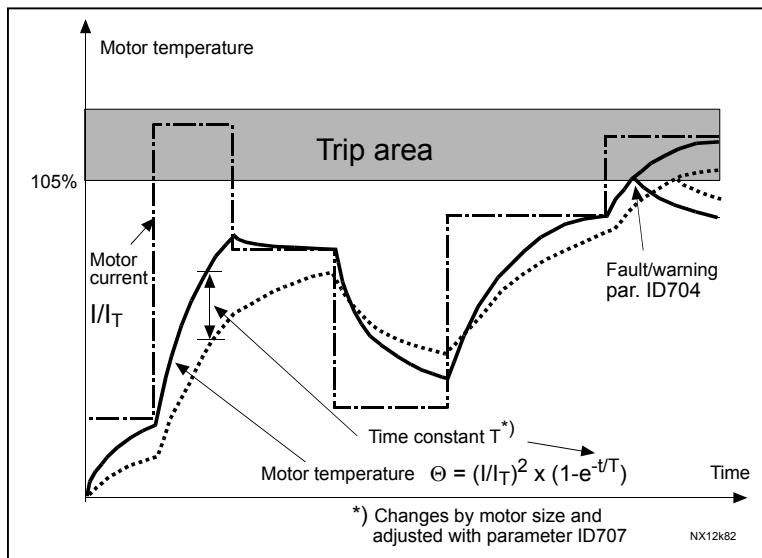

Figure 43. Motor temperature calculation

**709 Stall protection 234 (2.7.13)**

- 0 = No response
- 1 = Warning
- 2 = Fault, stop mode after fault according to [ID506](#)
- 3 = Fault, stop mode after fault always by coasting

Setting the parameter to **0** will deactivate the protection and reset the stall time counter.  
See chapter 6.2.

**710 Stall current limit 234 (2.7.14)**

The current can be set to 0.0...2\*I<sub>H</sub>. For a stall stage to occur, the current must have exceeded this limit. See Figure 44.

The software does not allow entering a greater value than I<sub>H</sub>\*2. If parameter [ID113](#) Nominal current of motor is changed, this parameter is automatically restored to the default value (I<sub>H</sub>). See chapter 6.2.

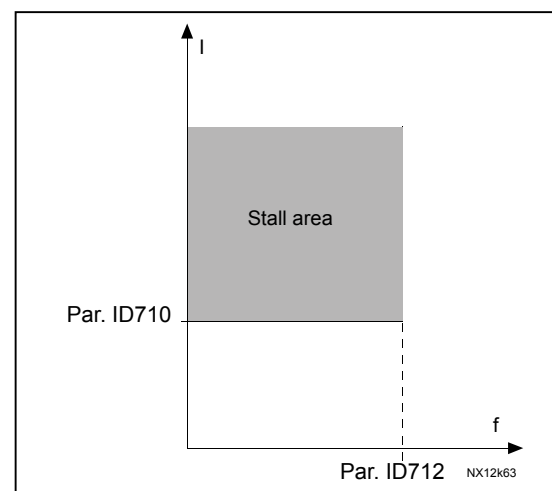

Figure 44. Stall characteristics settings

**711 Stall time 234 (2.7.15)**

This time can be set between 1.0 and 120.0s.

This is the maximum time allowed for a stall stage. The stall time is counted by an internal up/down counter. If the stall time counter value goes above this limit the protection will cause a trip (see ID709). See chapter 6.2.

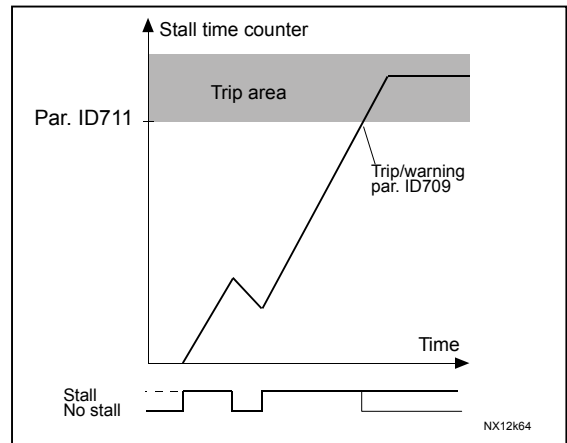

Figure 45. Stall time count

**712 Stall frequency limit 234 (2.7.16)**

The frequency can be set between  $1-f_{\max}$  (ID102). For a stall state to occur, the output frequency must have remained below this limit. See chapter 6.2.

**713 Underload protection 234 (2.7.17)**

0 = No response

1 = Warning

2 = Fault, stop mode after fault according to ID506

3 = Fault, stop mode after fault always by coasting

If tripping is set active the drive will stop and activate the fault stage.

Deactivating the protection by setting the parameter to 0 will reset the underload time counter to zero. See chapter 6.3.

**714 Underload protection, field weakening area load 234 (2.7.18)**

The torque limit can be set between 10.0—150.0 %  $\times T_{nMotor}$ .

This parameter gives the value for the minimum torque allowed when the output frequency is above the field weakening point. See Figure 46.

If you change parameter ID113 (Motor nominal current) this parameter is automatically restored to the default value. See chapter 6.3.

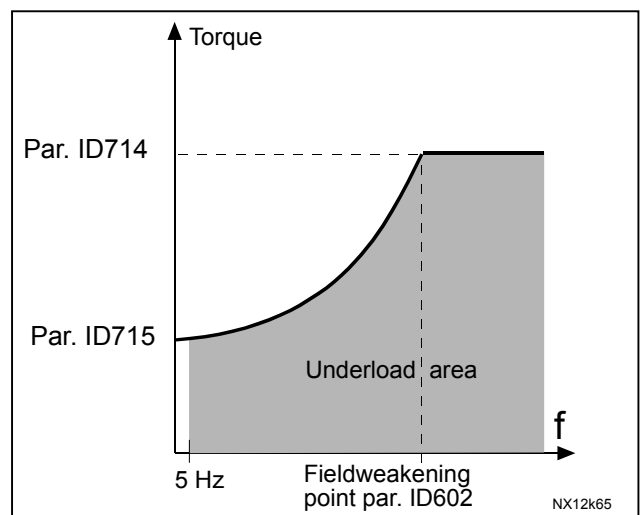

Figure 46. Setting of minimum load

**715 Underload protection, zero frequency load 234 (2.7.19)**

The torque limit can be set between 5.0—150.0 % x  $T_{nMotor}$ .

This parameter gives value for the minimum torque allowed with zero frequency. See Figure 46.

If you change the value of parameter **ID113** (Motor nominal current) this parameter is automatically restored to the default value. See chapter 6.3.

**716 Underload time 234 (2.7.20)**

This time can be set between 2.0 and 600.0 s.

This is the maximum time allowed for an underload state to exist. An internal up/down counter counts the accumulated underload time. If the underload counter value goes above this limit the protection will cause a trip according to parameter **ID713**. If the drive is stopped the underload counter is reset to zero. See Figure 47 and chapter 6.3.

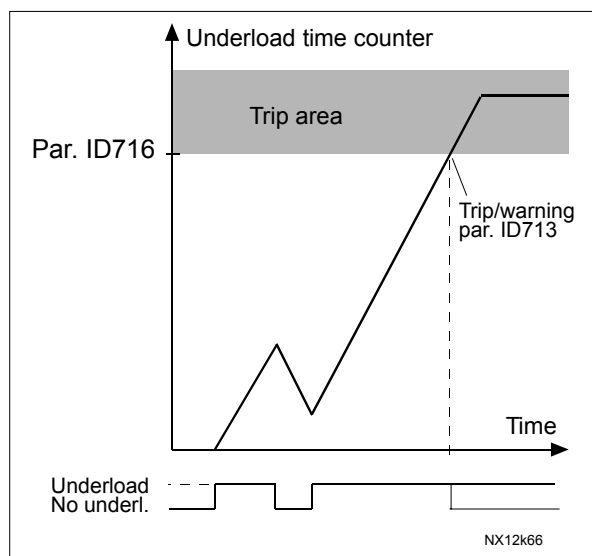

Figure 47. Underload time counter function

**717 Automatic restart: Wait time 234 (2.8.1)**

Defines the time before the frequency converter tries to automatically restart the motor after the fault has disappeared.

**718 Automatic restart: Trial time 234 (2.8.2)**

The Automatic restart function restarts the frequency converter when the faults selected with parameters **ID720** to **ID725** have disappeared and the waiting time has elapsed.

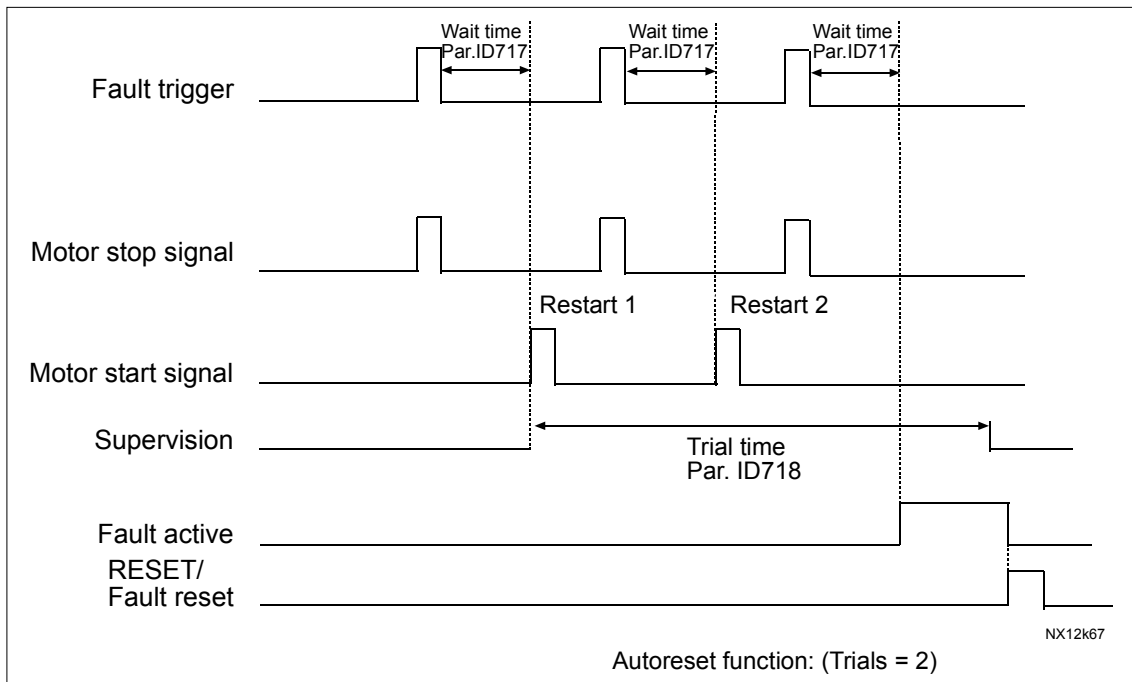

Figure 48. Example of Automatic restarts with two restarts

Parameters ID720 to ID725 determine the maximum number of automatic restarts during the trial time set by parameter ID718. The time count starts from the first autorestart. If the number of faults occurring during the trial time exceeds the values of parameters ID720 to ID725 the fault state becomes active. Otherwise the fault is cleared after the trial time has elapsed and the next fault start the trial time count again.

If a single fault remains during the trial time, a fault state is true.

**719 Automatic restart: Start function 234 (2.8.3)**

The Start function for Automatic restart is selected with this parameter. The parameter defines the start mode:

- 0 = Start with ramp
- 1 = Flying start
- 2 = Start according to ID505

**720 Automatic restart: Number of tries after undervoltage fault trip 234 (2.8.4)**

This parameter determines how many automatic restarts can be made during the trial time set by parameter ID718 after and undervoltage trip.

- 0 = No automatic restart
- >0 = Number of automatic restarts after undervoltage fault. The fault is reset and the drive is started automatically after the DC-link voltage has returned to the normal level.

**721 Automatic restart: Number of tries after overvoltage trip 234 (2.8.5)**

This parameter determines how many automatic restarts can be made during the trial time set by parameter [ID718](#) after an overvoltage trip.

- 0 = No automatic restart after overvoltage fault trip
- >0 = Number of automatic restarts after overvoltage fault trip. The fault is reset and the drive is started automatically after the DC-link voltage has returned to the normal level.

**722 Automatic restart: Number of tries after overcurrent trip 234 (2.8.6)**

(NOTE! IGBT temp fault also included)

This parameter determines how many automatics restarts can be made during the trial time set by [ID718](#).

- 0 = No automatic restart after overcurrent fault trip
- >0 = Number of automatic restarts after overcurrent trip, saturation trip and IGBT temperature faults.

**723 Automatic restart: Number of tries after reference trip 234 (2.8.7)**

This parameter determines how many automatics restarts can be made during the trial time set by [ID718](#).

- 0 = No automatic restart after reference fault trip
- >0 = Number of automatic restarts after the analogue current signal (4...20mA) has returned to the normal level ( $\geq 4\text{mA}$ )

**725 Automatic restart: Number of tries after external fault trip 234 (2.8.9)**

This parameter determines how many automatics restarts can be made during the trial time set by [ID718](#).

- 0 = No automatic restart after external fault trip
- >0 = Number of automatic restarts after external fault trip

**726 Automatic restart: Number of tries after motor temp. fault trip 234 (2.8.8)**

This parameter determines how many automatics restarts can be made during the trial time set by [ID718](#).

- 0 = No automatic restart after Motor temperature fault trip
- >0 = Number of automatic restarts after the motor temperature has returned to its normal level

**727 Response to undervoltage fault 234 (2.7.5)**

- 1 = Warning
- 2 = Fault, stop mode after fault according to [ID506](#)
- 3 = Fault, stop mode after fault always by coasting

For the undervoltage limits, see the product's User's Manual.

**728**      **4mA reference fault: preset frequency reference**      **234**      (2.7.2)

If the value of parameter [ID700](#) is set to 3 and the 4mA fault occurs then the frequency reference to the motor is the value of this parameter.

**730**      **Input phase supervision**      **234**      (2.7.4)

0 = No response

1 = Warning

2 = Fault, stop mode after fault according to [ID506](#)

3 = Fault, stop mode after fault always by coasting

The input phase supervision ensures that the input phases of the frequency converter have an approximately equal current.

**731**      **Automatic restart**      **1**      (2.20)

The Automatic restart is taken into use with this parameter.

0 = Disabled

1 = Enabled

The function resets the following faults (max. three times) (see the product's User's Manual):

- Overcurrent (F1)
- Overvoltage (F2)
- Undervoltage (F9)
- Frequency converter overtemperature (F14)
- Motor overtemperature (F16)
- Reference fault (F50)

**732**      **Response to thermistor fault**      **234**      (2.7.21)

0 = No response

1 = Warning

2 = Fault, stop mode after fault according to [ID506](#)

3 = Fault, stop mode after fault always by coasting

Setting the parameter to 0 will deactivate the protection.

**733**      **Response to fieldbus fault**      **234**      (2.7.22)

Set here the response mode for the fieldbus fault if a fieldbus board is used. For more information, see the respective Fieldbus Board Manual.

See parameter [ID732](#).

**734**      **Response to slot fault**      **234**      (2.7.23)

Set here the response mode for a board slot fault due to missing or broken board.

See parameter [ID732](#).

**1017 Sleep Delay** 234 (2.1.17, 2.1.15)

The minimum amount of time the frequency has to remain below the Min producing level before the frequency converter is going to sleep mode. The SleepDelay cannot be shorter than OwnStopDelay.

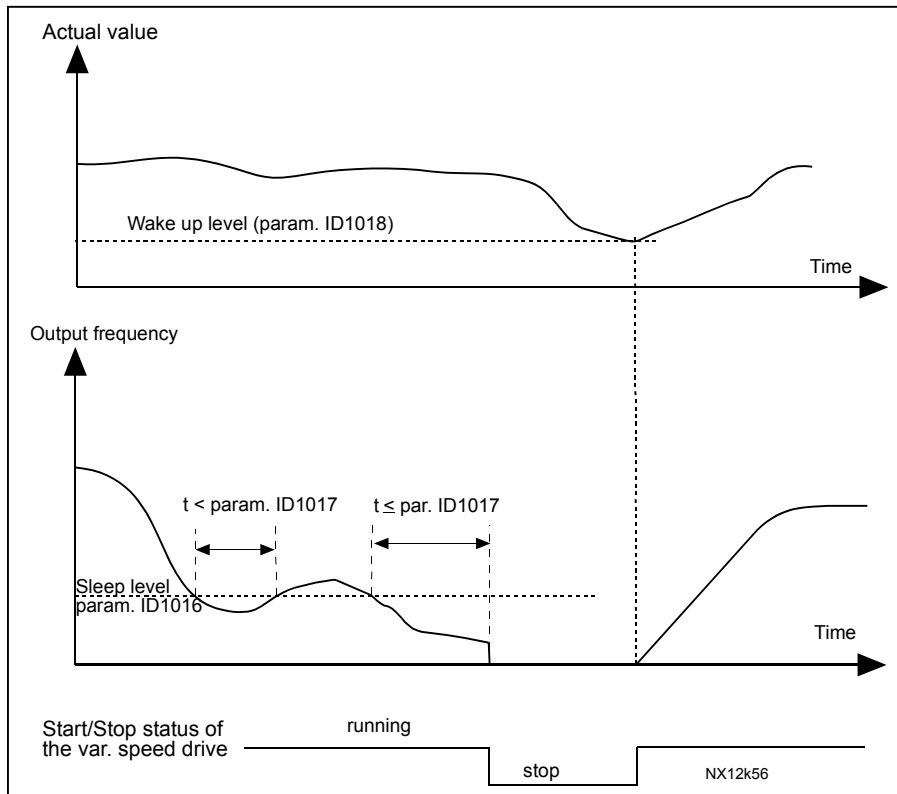

Figure 49. Frequency converter sleep function

**1018 Wake-up level** 234 (2.1.18, 2.1.16)

The wake-up level defines the level below which the actual value must fall or which has to be exceeded before the Run state of the frequency converter is restored. See Figure 49.

**1019 Wake-up function** 234 (2.1.19, 2.1.17)

This parameter defines whether the restoration of the Run state occurs when the actual value signal falls below or exceeds the *Wake-up level* (par. ID1018). See Figure 49 and Figure 50.

Par. value	Function	Limit	Description
0	Wake-up happens when actual value goes below the limit	The limit defined with parameter ID1018 is in percent of the maximum actual value	<p>Actual value signal</p> <p>100%</p> <p>Par. ID1018=30%</p> <p>time</p> <p>Start Stop</p>
1	Wake-up happens when actual value exceeds the limit	The limit defined with parameter ID1018 is in percent of the maximum actual value	<p>Actual value signal</p> <p>100%</p> <p>Par. ID1018=60%</p> <p>time</p> <p>Start Stop</p>
2	Wake up happens when actual value goes below the limit	The limit defined with parameter ID1018 is in percent of the current value of the reference signal	<p>Actual value signal</p> <p>100%</p> <p>reference=50%</p> <p>Par.ID1018=60% limit=60%*reference=30%</p> <p>time</p> <p>Start Stop</p>
3	Wake up happens when actual value exceeds the limit	The limit defined with parameter ID1018 is in percent of the current value of the reference signal	<p>Actual value signal</p> <p>100%</p> <p>Par.ID1018=140% limit=140%*reference=70%</p> <p>reference=50%</p> <p>time</p> <p>Start Stop</p>

NX12k88.fh8

Figure 50 Selectable wake-up functions



- 1500**     *Own ID number*                    **234**     (2.1.21, 2.1.19)
- Each drive in the installation must be given a unique number. The communication between the drives will not work properly if the number is "0" or if two drives have the same ID number.
- 1501**     *Interval time*                            **234**     (2.1.23, 2.1.20, 2.1.22)
- Time (hours) after which the automatic change will occur. Maximum time is 169h.
- Special values:  
**0** = 5 minutes  
**170** = Autochange is deactivated
- 1502**     *Number of drives*                         **2**        (2.1.22)
- The total amount of drives in the installation which are connected to the communication line. The maximum amount of drives in an installation is 3. This parameter is set by the installation. If you take one drive out (for pump service), this parameter does not have to be changed.
- 1503**     *Running hours of the period*             **234**     (V1.21)
- 1504**     *Running minutes of the period*         **234**     (V1.22)
- The time that the drive has been running since the last autochange.
- 1505**     *Next start delay*                         **24**        (2.1.15)
- This parameter is used to create hysteresis on starting the next drive.
- 1506**     *Reference step*                             **234**     (2.1.24, 2.1.30, 2.1.23)
- The reference value is increased by this value when the drive is working as an auxiliary drive.
- 1508**     *DIN2 start function*                       **234**     (2.2.1)
- Defines how the start command from DIN2 is activated:
- 0**    DIN2 alone will start the motor at nominal speed  
**1**    DIN1 to be selected before DIN2 starts the motor to run at nominal speed
- 1509**     *DIN4 function*                             **234**     (2.2.3)
- The digital input DIN4 has 12 possible functions. If it need not be used, set the value of the parameter to 0. The selections are the same as for ID301.
- 1510**     *Impeller cleaning time*                 **3**        (2.1.21)
- When the drive is regulating, e.g. after an autochange, it will accelerate the motor to MaxProdLimit (P2.1.2) and keep this speed for the time set with this parameter. After this time the drive will continue regulating. The idea with this is to clean the impeller of the pump.  
If the parameter is set to 0 this function is by-passed.

**1511 Drive status 234 (V1.23)**

Gives a message about the status of the drive. See chapter 0.2 for details.

**1512 Own stop delay 24 (2.1.16)**

This parameter is used to create the hysteresis when the drive stops itself. The time that the drive waits at Null Producing Limit (ID101) before it stops itself and sends out a request for the drive running at nominal producing speed to start regulating.

**NOTE!** If both ID1505 and ID1512 have the value "0", only one drive is handling all the pumping capacity. In other words, the auxiliary drives are NOT requested, but the autochange function works.

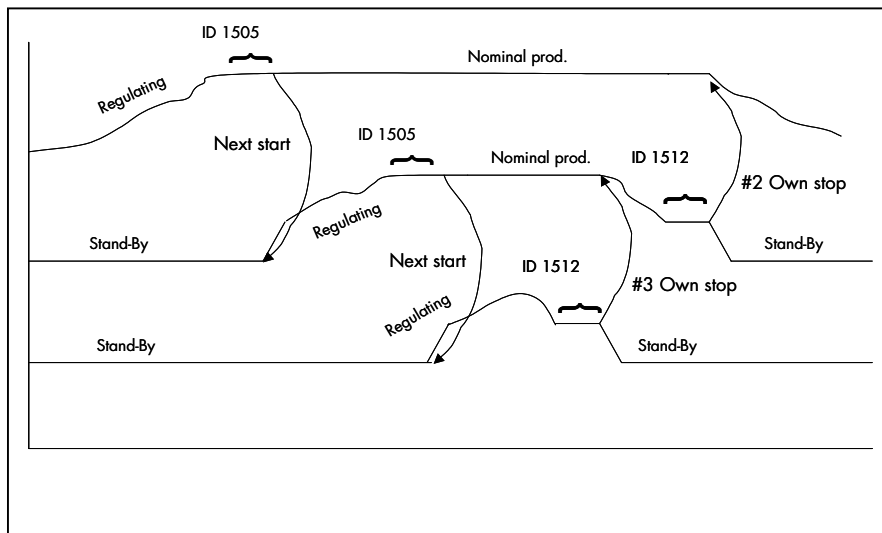

Figure 51. Use of parameters ID1505 and ID1512

**1513 Constant production frequency 23 (2.1.25, 2.1.31)**

Frequency at which the drive will lock after the max prod limit is reached and the regulation is handled by another drive.

The value has to be between ID101 and ID102. If the value = 0 the drive will lock at the max producing frequency, ID102.

**1518 Actual value 1 supervision, supervised limit 234 (2.7.24)**

The limit given in percent of actual value being supervised.

**1519 Actual value over/under supervised limit 234 (2.7.25)**

0 = No action

1 = Actual value is above the supervised limit (ID1518)

2 = Actual value is below the supervised limit (ID1518)

- 1522**     *Actual value supervision response*     **234**     (2.7.26)
- Set here the response mode for the actual value supervision.  
If other than 0 is selected the message code 55 appears on the keypad when supervision is activated.  
0 = No response  
1 = Warning  
2 = Fault, stop mode after fault according to par. [ID506](#)  
3 = Fault, stop mode after fault always by coasting
- 1523**     *Actual value supervision*     **234**     (2.3.29.16)
- The supervision value of the actual value is reached.  
See [ID1518](#), [1519](#), [1522](#), [1540](#).
- 1524**     *R01 Signal*     **234**     (2.3.28.1)
- Connect the R01 signal to the digital output of your choice with this parameter. See chapter 0.4, Function / terminal programming methods.  
The status/information selected in ID1525 or ID1529 is sent to the port defined by this parameter.  
**Note** that the digital output D01 (A.1) is used for communication and cannot be programmed.
- 1525**     *R01 Content*     **234**     (2.3.28.2)
- Selects the board and the channel to where the digital output 1 is written. The same functions that are described for ID:s 432 – 439, 443, 447, 448, 450 - 452, 454, 1523.
- 1526**     *R01 On delay*     **234**     (2.3.28.3)
- The time before the relay R01 is activated.
- 1527**     *R01 Off delay*     **234**     (2.3.28.4)
- The time before the relay R01 is de-activated.
- 1528**     *R02 Signal*     **234**     (2.3.28.5)
- Connect the R02 signal to the digital output of your choice with this parameter. Note that the digital output D01 (A.1) is used for communication and cannot be programmed.  
See also ID1524.
- 1529**     *R02 Content*     **234**     (2.3.28.6)
- Selects the board and the channel to where the digital output 2 is written. See also ID1525.
- 1530**     *R02 On delay*     **234**     (2.3.28.7)
- See ID1526.
- 1531**     *R02 Off delay*     **234**     (2.3.28.8)
- See [ID1527](#).

- 1532**     *A11 Signal selection*                     **234**     (2.2.13)  
 Selects the board and the channel at which the analogue input 1 is read.
- 1533**     *A12 Signal selection*                     **234**     (2.2.19)  
 Selects the board and the channel at which the analogue input 2 is read.
- 1534**     *lout 3 signal*                                 **234**     (2.3.22, 2.3.21)  
 Selects the board and the channel to which the analogue output 3 is written.
- 1535**     *lout 3 content*                                 **234**     (2.3.23, 2.3.22)  
 See [ID307](#).
- 1536**     *lout 3 filter*                                 **234**     (2.3.24, 2.3.23)  
 See [ID308](#).
- 1537**     *lout 3 Invert*                                 **234**     (2.3.25, 2.3.24)  
 See [ID309](#).
- 1538**     *lout 3 Minimum*     **234**     (2.3.26, 2.3.25)  
 See [ID310](#).
- 1539**     *lout 3 Scale*                                 **234**     (2.3.27, 2.3.26)  
 See par [ID310](#).
- 1540**     *Actual value supervision response time*                     **234**     (2.7.27)  
 The time the drive waits before it responds according to [ID1522](#).
- 1541**     *Value of actual value supervision, to relay output*     **234**     (2.3.14, 2.3.13)  
 The value at which the actual value supervision is activated. The value is given in % of the actual value.
- 1542**     *Actual value below/above set value, to relay*                     **234**     (2.3.15, 2.3.14)  
 Selects if the relay is activated when the actual value goes below or above the supervision value set with [ID1541](#).
- 1543**     *Drive status word*                                 **234**     (V1.24)  
 More detailed information about the status of the drive.  
 The status word is needed by Vacon service personnel in case of problems running the application.

1544	<i>Actual value special display minimum</i>	234	(2.1.29, 2.1.33, 2.1.25)
1545	<i>Actual value special display maximum</i>	234	(2.1.30, 2.1.34, 2.1.26)
1546	<i>Actual value special display decimals</i>	234	(2.1.31, 2.1.35, 2.1.27)

With these parameters the minimum and maximum values as well as the number of decimals of the actual value special display can be set. Find the actual value display in menu **M1**, *Monitoring values*.

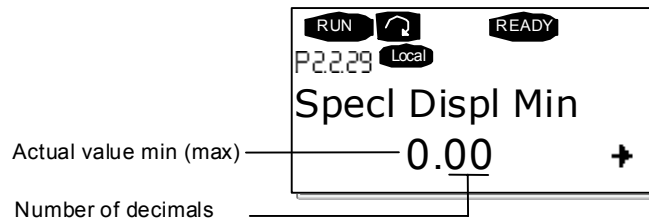

1547	<i>Actual value special display</i>	234	(V1.25)
------	-------------------------------------	-----	---------

Actual value display. See ID1544 to ID1546.

1548	<i>Direction</i>	234	(2.1.28, 2.1.32, 2.1.24)
------	------------------	-----	--------------------------

If the motor is running in wrong direction it is possible to reverse it by using this parameter.

**NOTE!** The reversed direction of the motor is indicated by the monitoring values.

1549	<i>Actual value special display unit</i>	234	(2.1.32, 2.1.36, 2.1.28)
------	--	-----	--------------------------

The Actual value special display parameters are used to convert and display the actual value signal in a form more informative to the user.

The Actual value special display parameters are available in all other applications of the Water Solutions applications package but the *Basic Application*:

Example: The actual value signal sent from a sensor (in mA) tells you the amount of waste water pumped from a tank per second. The signal range is 0(4)...20mA. Instead of receiving the level of the actual value signal (in mA) on the display, you wish to receive the amount of water pumped in m<sup>3</sup>/s. You then set a value for par. ID1033 to correspond to the minimum signal level (0/4 mA) and another value for par. ID1034 to correspond to the maximum signal level (20 mA). The number of decimals needed can be set with par. ID1035 and the unit (m<sup>3</sup>/s) with par. ID1036. The level of the actual value signal is then scaled between the set min and max values and displayed in the selected unit.

The following units can be selected (par. ID1549):

Value	Unit	On keypad
0	Not Used	
1	%	%
2	°C	C
3	m	m
4	bar	bar
5	mbar	mbar
6	Pa	Pa
7	kPa	kPa

8	PSI	PSI
9	m / s	m/s
10	l / s	l/s
11	l / min	l/m
12	l / h	l/h
13	m <sup>3</sup> / s	m <sup>3</sup> /s
14	m <sup>3</sup> / min	m <sup>3</sup> /m
15	m <sup>3</sup> / h	m <sup>3</sup> /h
16	°F	F
17	ft	ft
18	gal / s	GPS
19	gal / min	GPM
20	gal / h	GPH
21	ft <sup>3</sup> / s	CFS
22	ft <sup>3</sup> / min	CFM
23	ft <sup>3</sup> / h	CFH
24	A	A
25	V	V
26	W	W
27	kW	kW
28	Hp	Hp

Table 50. Unit display on keypad

**NOTE:** The maximum number of characters that can be shown on keypad is 4. This means that in some cases the display of the unit on the keypad does not comply with the standards.

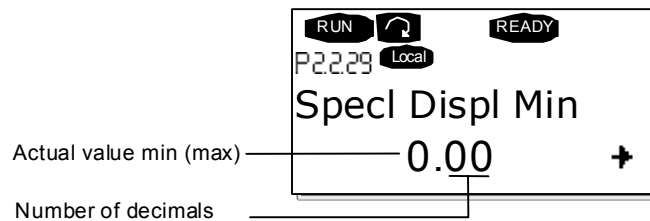

**1550** *Follower filter time* **4** (2.2.39)

Defines the filtering time of the analogue output signal. Setting this parameter value 0 will deactivate filtering.

**1552** *Follower signal inversion* **4** (2.2.40)

0 = No inversion  
1 = Signal inverted

**1553** *Error value low limit* **2** (2.1.27)

If this level is reached before the drive starts its controlling cycle the drive will ramp up to *Nominal production frequency* given in % of the reference value. See Figure 52.

**Note:** If the values of both parameters ID1553 and ID1554 are set to maximum (500) the error value supervision functions are bypassed.

**1554**     **Error value high limit**                    **2**     (2.1.26)

If the actual value suddenly rises above this limit when running at *Nominal production frequency* (ID102 or ID1513) the drive will drop its output frequency to *Null production frequency* (ID101). The output frequency will stay at this level until the actual value falls below the limit set in ID1553 or the drive starts its controlling sequence. The drive starts then to regulate from the *Null production frequency* given in % of the reference value. See Figure 52.

**Note:** If the values of both parameters ID1553 and ID1554 are set to maximum (500) the error value supervision functions are bypassed.

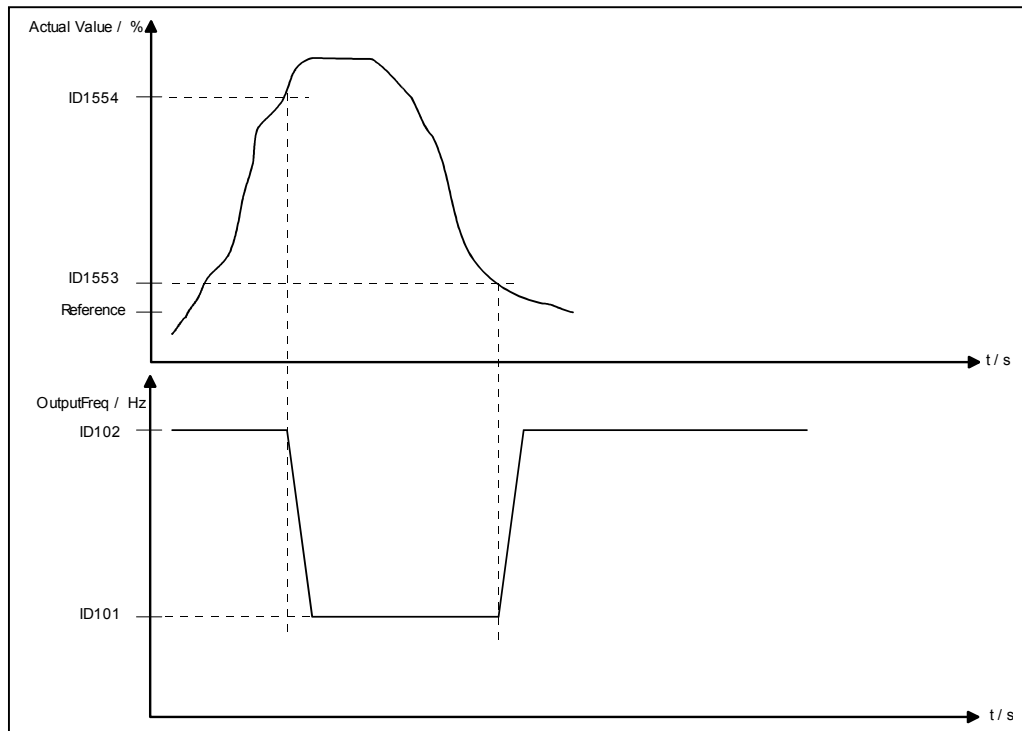

Figure 52. Error value limits in use

**NOTE!** Ramp2 is used in ID1553 and ID1554 when dropping and increasing the output frequency.

**1560**     **Run mode for the leading drive**                    **3**     (2.1.21)

In the *Advanced Level Control Application*, the leading drive can either run linearly between the set high and low limits (ID1561 and ID 1562) or work as a PID controller.

0 = PID

1 = Linearly

**1561**     **Low limit for leading drive in Linear mode**                    **3**     (2.1.22)

This parameter defines the lower frequency limit for the leading drive running linearly. It is also a "security stop" level for all drives in the system. The low limit corresponds to the *Null production frequency*, ID101. The value is given in % of the actual value. See Figure 53.

**1562**     **High limit for leading drive in Linear mode**                    **3**     (2.1.23)

This parameter defines the higher frequency limit for the leading drive running linearly. The high limit corresponds to the *Max production frequency*, ID102. The value is given in % of the actual value. See Figure 53.

**1563**     *Run mode for the auxiliary drive(s)*     **3**     (2.1.24)

When the auxiliary drive has reached the limit where it is started it will either run at the set nominal production speed or run linearly between the set upper and lower limits. (See ID1565 to ID1568).

0 = Nominal production speed  
1 = Linearly

**1564**     *Start level for auxiliary drives running linearly*     **3**     (2.1.25)

When the auxiliary drive are set to run linearly (ID1563 = 1) can it be set to start either from the upper or the lower limit.

0 = Start at Low level  
1 = Start at High level

**1565**     *Lower level for auxiliary drive 1*     **3**     (2.1.26)

The lower point of the frequency range within which the auxiliary drive 1 is working. The value is given in % of the actual value. See Figure 53.

**1566**     *Higher level for auxiliary drive 1*     **3**     (2.1.27)

The higher point of the frequency range within which the auxiliary drive 1 is working. The value is given in % of the actual value. See Figure 53

**1567**     *Lower level for auxiliary drive 2*     **3**     (2.1.28)

The lower point of the frequency range within which the auxiliary drive 2 is working. The value is given in % of the actual value. See Figure 53.

**1568**     *Upper level for auxiliary drive 2*     **3**     (2.1.29)

The higher point of the frequency range within which the auxiliary drive 2 is working. The value is given in % of the actual value. This level is also a "security start" level for all drives in the system. See Figure 53



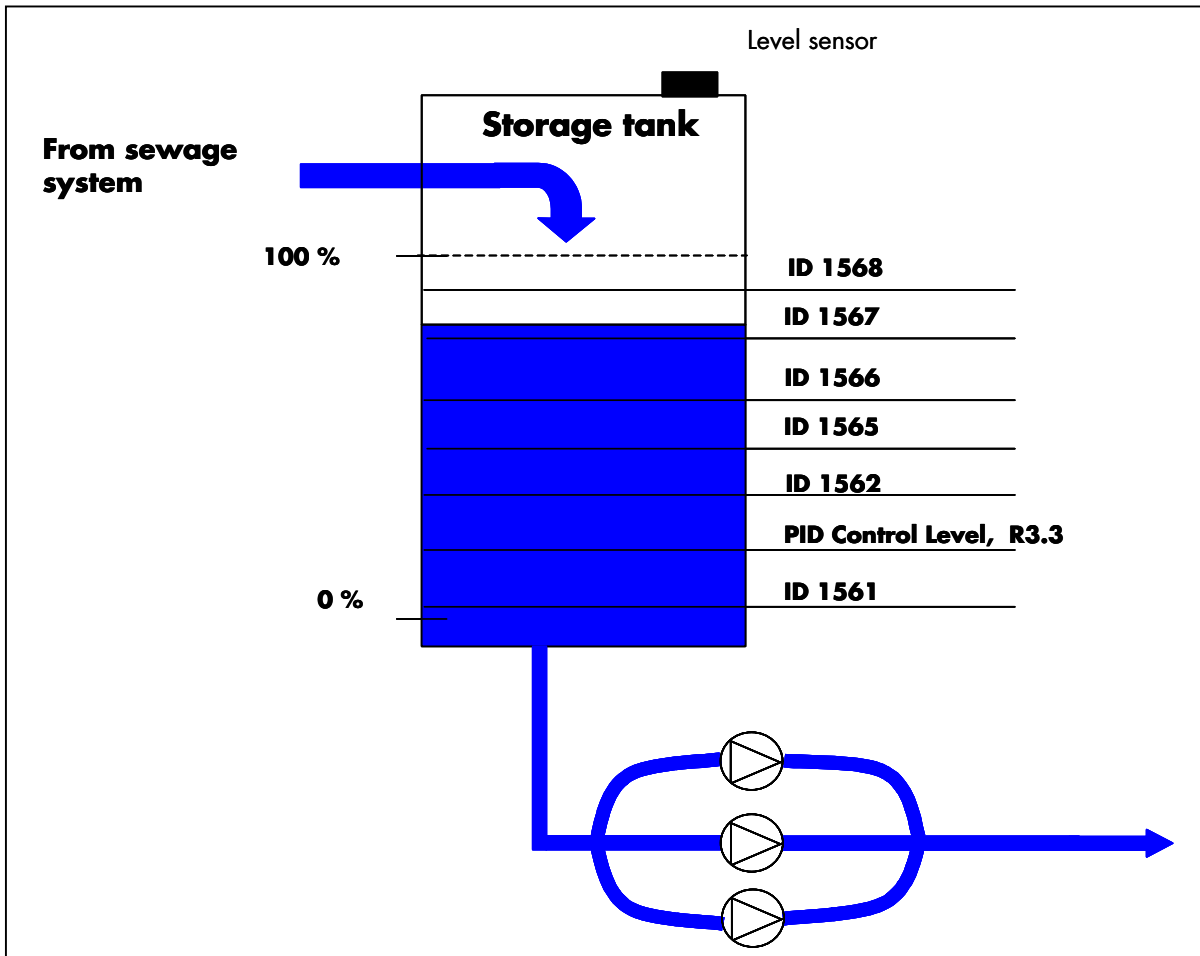

Figure 53. Different levels in Advanced Level Control application

## 5.1 Keypad control parameters

Unlike the parameters listed above, these parameters are located in the **M3** menu of the control keypad. The reference parameters do not have an ID number.

### 114 *Stop button activated* (3.4, 3.6)

If you wish to make the Stop button a "hotspot" which always stops the drive regardless of the selected control place, give this parameter the value 1.

See also parameter ID125.

### 125 *Control Place* (3.1)

The active control place can be changed with this parameter. For more information, see the product's User's Manual.

Pushing the *Start button* for 3 seconds selects the control keypad as the active control place and copies the Run status information (Run/Stop, direction and reference).

### 123 *Keypad Direction* (3.3)

- 0 Forward: The rotation of the motor is forward, when the keypad is the active control place.
- 1 Reverse: The rotation of the motor is reversed, when the keypad is the active control place.

For more information, see the product's User's Manual.

### 167 *PID reference 1* 234 (3.4)

The PID controller keypad reference can be set between 0% and 100%. This reference value is the active PID reference if parameter [ID332](#) = 2.

### 168 *PID reference 2* 234 (3.5)

The PID controller keypad reference 2 can be set between 0% and 100%. This reference is active if the DIN5 function=13 and the DIN5 contact is closed.

### R3.2 *Keypad Reference* (3.2)

The frequency reference can be adjusted from the keypad with this parameter.

The output frequency can be copied as the keypad reference by pushing the *Stop button* for 3 seconds when you are on any of the pages of menu **M3**. For more information, see the product's User's Manual.

## 6. APPENDICES

In this chapter you will find additional information on special parameter groups. Such groups are:

- *Parameters of Motor thermal protection (Chapter 6.1)*
- *Parameters of Stall protection (Chapter 6.2)*
- *Parameters of Underload protection (Chapter 6.3)*
- *Fieldbus control parameters (Chapter 6.4)*

### 6.1 Parameters of motor thermal protection (ID's 704 to 708):

#### General

The motor thermal protection is to protect the motor from overheating. The Vacon drive is capable of supplying higher than nominal current to the motor. If the load requires this high current there is a risk that the motor will be thermally overloaded. This is the case especially at low frequencies. At low frequencies the cooling effect of the motor is reduced as well as its capacity. If the motor is equipped with an external fan the load reduction at low speeds is small.

The motor thermal protection is based on a calculated model and it uses the output current of the drive to determine the load on the motor.

The motor thermal protection can be adjusted with parameters. The thermal current  $I_T$  specifies the load current above which the motor is overloaded. This current limit is a function of the output frequency.

The thermal stage of the motor can be monitored on the control keypad display. See the product's User's Manual.



**CAUTION!** *The calculated model does not protect the motor if the airflow to the motor is reduced by blocked air intake grill.*

### 6.2 Parameters of Stall protection (ID's 709 to 712):

#### General

The motor stall protection protects the motor from short time overload situations such as one caused by a stalled shaft. The reaction time of the stall protection can be set shorter than that of motor thermal protection. The stall state is defined with two parameters, [ID710 \(Stall current\)](#) and [ID712 \(Stall frequency limit\)](#). If the current is higher than the set limit and output frequency is lower than the set limit, the stall state is true. There is actually no real indication of the shaft rotation. Stall protection is a type of overcurrent protection.

### 6.3 Parameters of Underload protection (ID's 713 to 716):

#### General

The purpose of the motor underload protection is to ensure that there is load on the motor when the drive is running. If the motor loses its load there might be a problem in the process, e.g. a broken belt or a dry pump.

Motor underload protection can be adjusted by setting the underload curve with parameters [ID714](#) (Field weakening area load) and [ID715](#) (Zero frequency load), see below. The underload curve is a squared curve set between the zero frequency and the field weakening point. The protection is not active below 5Hz (the underload time counter is stopped).

The torque values for setting the underload curve are set in percentage which refers to the nominal torque of the motor. The motor's name plate data, parameter motor nominal current and the drive's nominal current  $I_H$  are used to find the scaling ratio for the internal torque value. If other than nominal motor is used with the drive, the accuracy of the torque calculation decreases.

### 6.4 Fieldbus control parameters (ID's 850 to 859)

The Fieldbus control parameters are used when the frequency or the speed reference comes from the fieldbus (Modbus, Profibus, DeviceNet etc.). With the Fieldbus Data Out Selection 1...8 you can monitor values from the fieldbus.



**Vaasa**

Vacon Oyj (Headquarters and Production)  
Runsorintie 7, 65380 Vaasa  
firstname.lastname@vacon.com  
tel. +358 (0) 201 2121  
fax: +358 (0) 201 212 205

**Helsinki**

Vacon Oyj  
Äyritie 12, 01510 Vantaa  
tel. +358 (0)201 212 600  
fax: +358 (0)201 212 699

**Tampere**

Vacon Oyj  
Alasniitynkatu 30, 33700 Tampere  
tel. +358 (0)201 2121  
fax: +358 (0)201 212 750

**Rotatek Finland Oy**

Laserkatu 6, 53850 Lappeenranta  
tel. +358 (0)5 6243 870  
fax: +358 (0)5 6243 871

**Vacon Traction Oy**

Alasniitynkatu 30, 33700 Tampere  
tel. +358 (0)201 2121  
fax: +358 (0)201 212 710

**SALES COMPANIES AND REPRESENTATIVE OFFICES:****Austria**

Vacon AT Antriebssysteme GmbH  
Aumühlweg 21  
2544 Leobersdorf  
vacon.austria@vacon.com  
tel. +43 2256 651 66  
fax: +43 2256 651 66 66

**Belgium**

Vacon Benelux NV/SA  
Interleuvenlaan 62  
3001 Heverlee (Leuven)  
info@vacon.be  
tel. +32 (0)16 394 825  
fax: +32 (0)16 394 827

**France**

Vacon France s.a.s.  
Batiment le Sextant  
462 rue Benjamin Delessert  
Zl de Moissy Cramayel  
BP 83  
77 554 Moissy Cramayel  
www.vacon-france.fr  
tel. +33 (0)1 64 13 54 11  
fax: +33 (0)1 64 13 54 21

**Germany**

Vacon GmbH  
Gladbecker Str. 425  
45329 Essen  
tel. +49 (0)201/80670-0  
fax: +49 (0)201/80670-93

**Great Britain**

Vacon Drives (UK) Ltd.  
Unit 11, Sunnyside Park  
Wheatfield Way, Hinckley  
LE10, 1PJ, Leicestershire  
vacon.uk@vacon.com  
tel. +44 (0)1455 611 515  
fax: +44 (0)1455 611 517

**Italy**

Vacon S.p.A.  
Via F.lli Guerra, 35  
42100 Reggio Emilia  
info@vacon.it  
tel. +39 0522 276811  
fax: +39 0522 276890

**The Netherlands**

Vacon Benelux BV  
Weide 40, 4206 CJ Gorinchem  
vacon.benelux@vacon.com  
tel. +31 (0)183 642 970  
fax: +31 (0) 183 642 971

**Norway**

Vacon AS  
Langgata 2  
3080 Holmestrand  
vacon@vacon.no  
tel. +47 330 96120  
fax: +47 330 96130

**PR China**

Vacon Plc  
Beijing Representative Office  
A205, Grand Pacific Garden Mansion  
8A Guanhua Road  
Beijing 100026  
www.vacon.com.cn  
vacon.china@vacon.com  
tel. +86 10 6581 3734  
fax: +86 10 6581 3754

**Russia**

ZAO Vacon Drives  
Bolshaja Jakimanka 31  
stroenie 18  
109180 Moscow  
www.ru.vacon.com  
tel. +7 (095) 974 1541  
fax: +7 (095) 974 1554

**ZAO Vacon Drives**

2ya Sovetskaya 7, office 210A  
191036 St. Petersburg  
www.ru.vacon.com  
tel. +7 (812) 332 1114  
fax: +7 (812) 279 9053

**Singapore**

Vacon Plc  
Singapore Representative Office  
102F Pasir Panjang Road  
#02-06 Citilink Warehouse Complex  
Singapore 118530  
vacon.singapore@vacon.com  
tel. +65 6278 8533  
fax: +65 6278 1066

**Spain**

Vacon Drives Ibérica S.A.  
Miquel Servet, 2. P.l. Bufalvent  
08240 Manresa  
www.vacon.es  
info@vacon.es  
tel. +34 93 877 45 06  
fax: +34 93 877 00 09

**Sweden**

Vacon AB  
Torget 1  
172 67 Sundbyberg  
tel. +46 (0)8 293 055  
fax: +46 (0)8 290 755